



### Construction

Energy saving variable speed circulating pump driven by a permanent magnet synchronous motor (pm) controlled by on board inverter.

### Applications

Heating and conditioning systems.

### Operating conditions

- Liquid temperature from +2 °C to +110 °C
- Ambient temperature from 0 °C to +40 °C
- Maximum permissible working pressure: 10 bar
- Storage: -20°C/+70°C max. relative humidity 95% at 40 °C
- Certifications: in conformity with CE requirements
- Sound pressure  $\leq$  40 dB (A).
- Minimum suction pressure: - 0,05 bar at 75 °C  
- 0,28 bar a 90 °C.
- Maximum glycol quantity: 20%.
- EMC according to: EN 55014-1, EN 55014-2  
EN 61000-3-2, EN 61000-3-2.
- Connections: threaded ports ISO 228: G 1 1/2, G 2.
- The benchmark for most efficient circulators is  $EEL \leq 0,20$ .

### Designation

NCE H 25 - 100 / 180

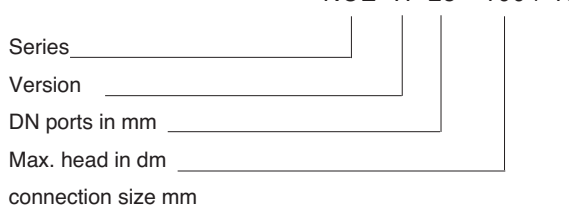

### Motor

- Synchronous motor with permanent magnet.
- Motor: variable speed
  - Standard voltage: single-phase 230 V (-10%;+6%)
  - Frequency: 50-60 Hz
  - Protection: IP 44
  - Insulation class: F
  - Overload protection (integrated).
  - Cable: phases and neutral.
  - Constructed in accordance with: EN 60335-1, EN 60335-2-51.

### Special features on request

- Additional module:
- analog input 0-10V
  - remote on/off input
  - output relay

Brass or cast iron unions.

## Features

### Smart pump

NCE H adapt its functions to the system: the circulator measures the pressure and the flow and adjusts the speed to the selected pressure.

### Easy use

There are different operating modes selectable from the control panel.

### Operating modes



**Automatic mode**

(factory setting):

In this mode the pump automatically sets the operating pressure, depending on the hydraulic system. This mode is recommended in most systems.



**Proportional pressure mode:**

The circulator changes the pressure proportionally to the current flow. The pressure value can be adjusted with the + and - buttons.



**Constant pressure mode:**

The circulator maintains the pressure constant when the reference flow changes. The pressure value can be adjusted with the + and - buttons.



**Fixed speed mode:**

The circulator works with constant curve and the curve could be changed using + e - buttons.



**Night mode:**

When the liquid temperature fall by 15-20°C the pump automatically swiches to night mode, in practice the circulator works at minimum curve. When the temperature rises again the pump comes back to the selected mode. The night mode could be selected with any operating mode.

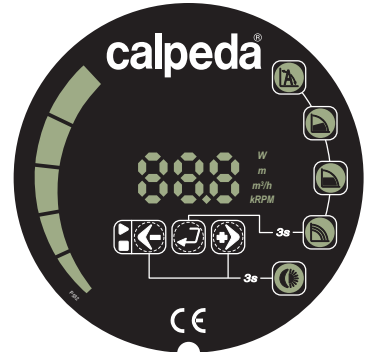

**Operating mode-control panel**

NCE H could works in:

- automatic mode
- proportional pressure mode
- constant pressure mode
- fixed speed mode
- night mode

The night mode could be selected with any operating mode.

### Coverage chart

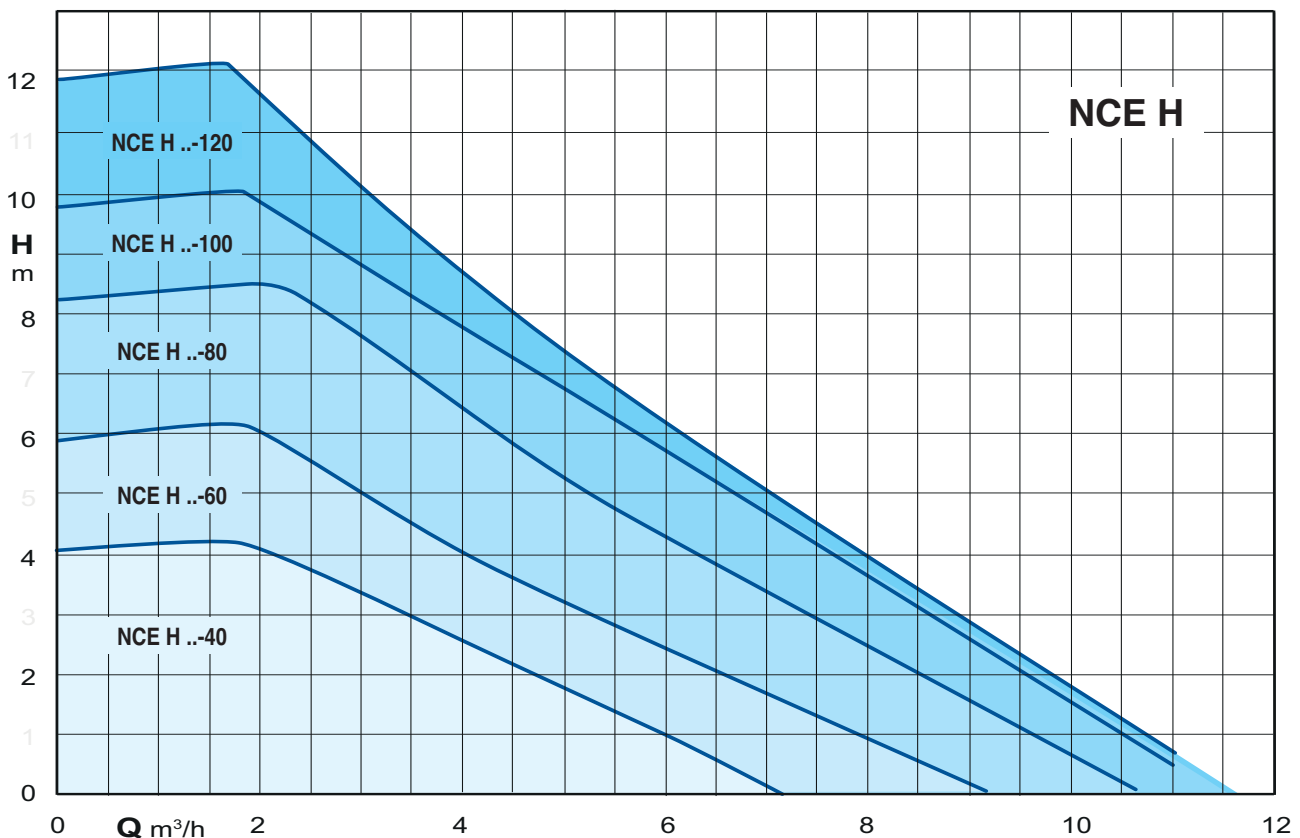

## Characteristic curves

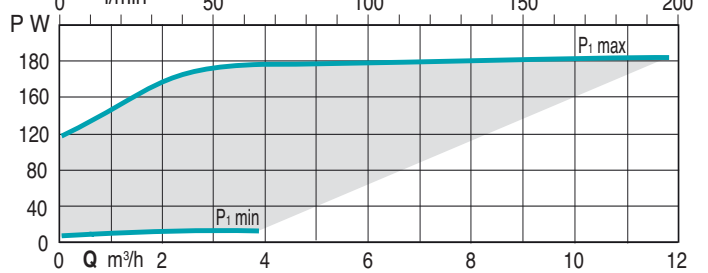
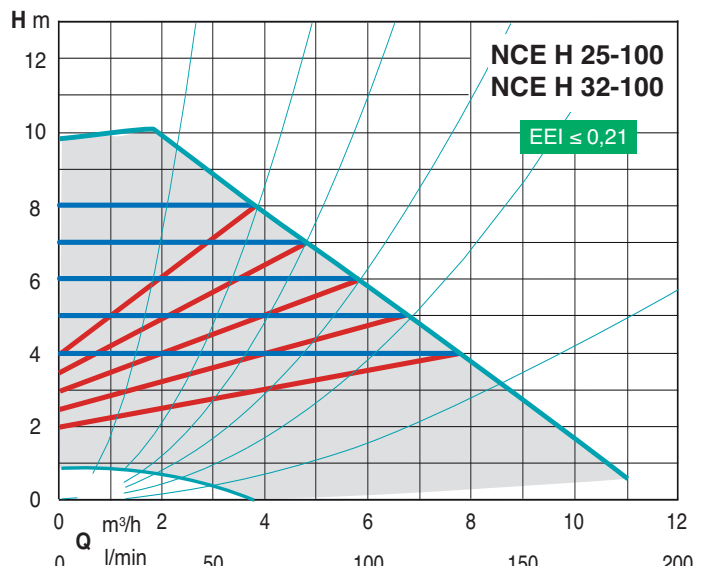
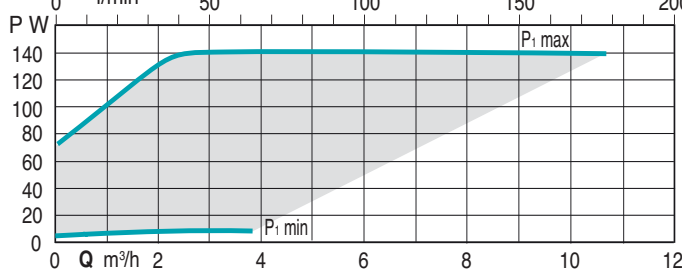
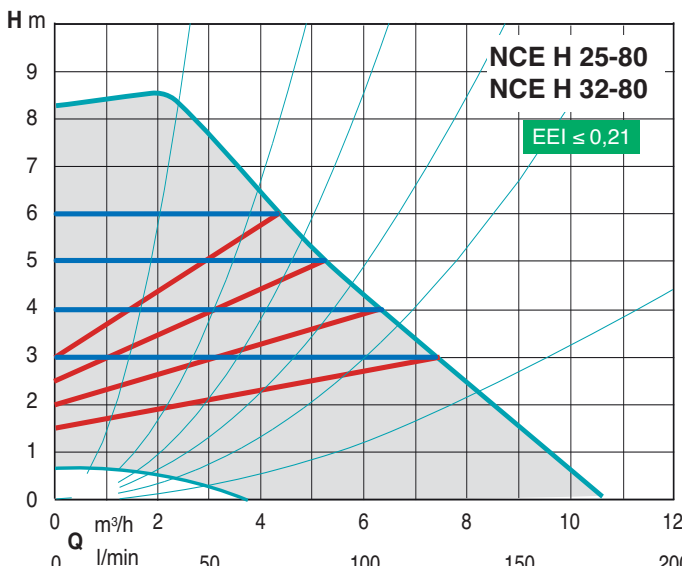
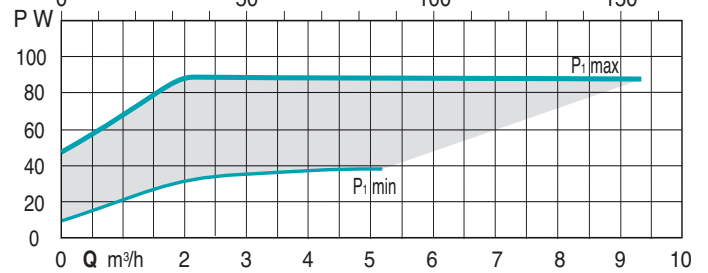
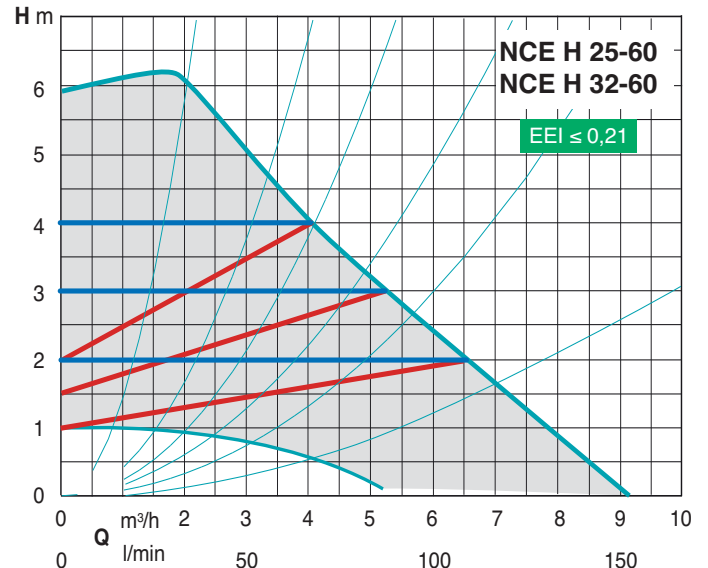
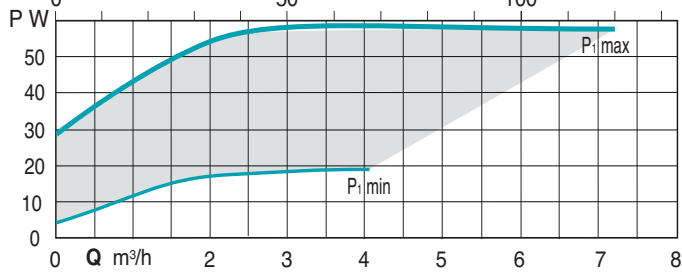
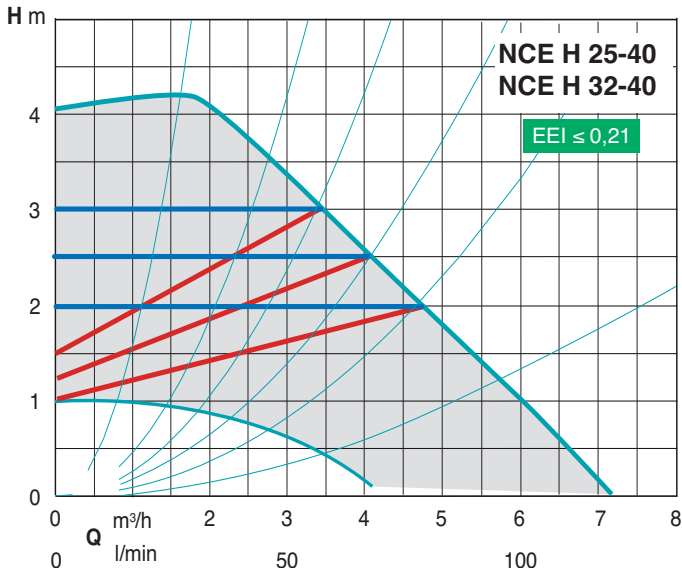

## Characteristic curves

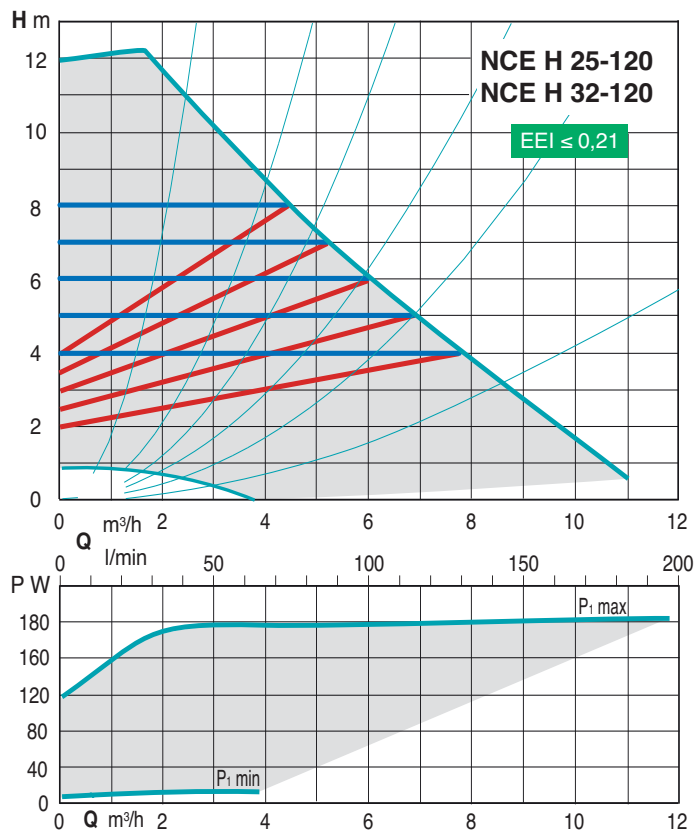

### Materials

Component	Pos.	Material
Pump casing	1	Cast iron GJL 200 EN 1561
Impeller	2	Composite
Shaft	3	Stainless steel
Bearings	4	Carbon
Thrust bearing	5	Ceramic
Rotor	6	Stainless steel jacket
Winding	7	Copper wire
Electronic card	8	-
Gasket	9	EPDM

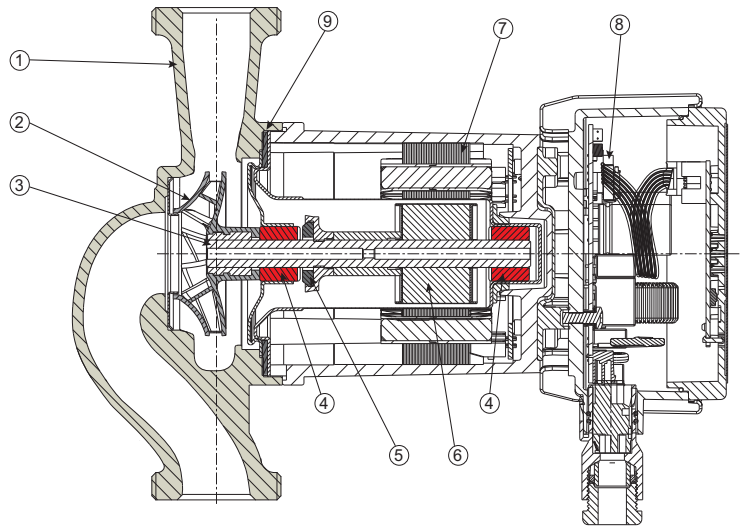

### Examples of installations

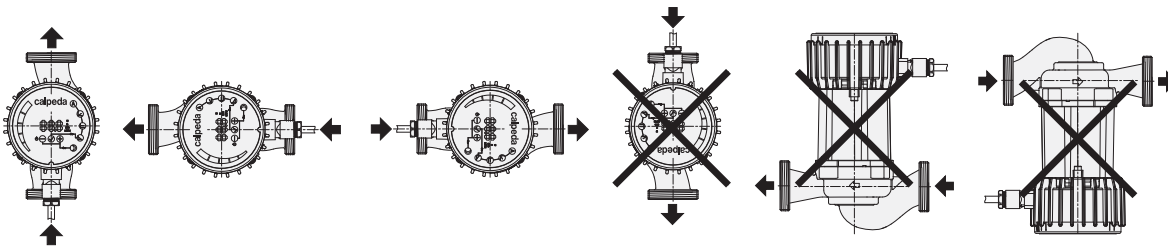

### Dimensions and weights

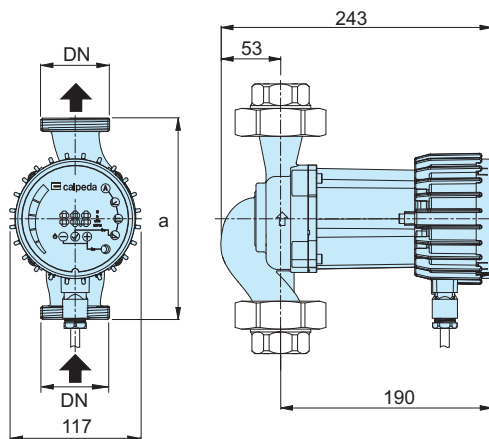

TYPE	DN	H m	Q m <sup>3</sup> /h	1~ 230 V		P <sub>1</sub>		a mm	kg
				A min	A max	W min	W max		
NCE H 25-40/180 NCE H 32-40/180	G 1 1/2 G 2	4	5	0,1	0,5	10	60	180	4 4,1
NCE H 25-60/180 NCE H 32-60/180	G 1 1/2 G 2	6	7,5	0,1	0,75	10	90	180	4 4,1
NCE H 25-80/180 NCE H 32-80/180	G 1 1/2 G 2	8	9	0,1	1,15	10	140	180	4 4,1
NCE H 25-100/180 NCE H 32-100/180	G 1 1/2 G 2	10	11	0,1	1,5	10	180	180	4 4,1
NCE H 25-120/180 NCE H 32-120/180	G 1 1/2 G 2	12	15	0,1	1,5	10	180	180	4 4,1

### Unions (on request)

TYPE	DN	DN1
KIT G 1 - G 1/2 (NCE . 15..)	G 1	G 1/2
KIT G 1 1/2 - G 1 (NCE . 25..)	G 1 1/2	G 1
KIT G 2 - G 1 1/4 (NCE . 32..)	G 2	G 1 1/4