

# 4-BLOCK

## 4" Close-coupled electric submersible pumps



Clean water



Civil use



Domestic use



Agricultural use



※ **Ready-to-install stainless steel submersible pump equipped with an integrated capacitor and thermal protector.**

※ **Patented hydraulics featuring fully independent, floating impellers, ensuring minimal impact from sand on pump performance.**

※ **These hydraulics have a minimum efficiency index (MEI) that far exceeds ErP requirements.**

※ **Outstanding performance .**

※ **Comes with a 20 m power cable.**

### PERFORMANCE RANGE

- Flow rate up to **200 l/min** (12 m<sup>3</sup>/h)
- Head up to **140 m**

### INSTALLATION AND USE

Designed to draw water from clean wells, even in the presence of sand (up to **200 g/m<sup>3</sup>**).

With their high efficiency, reliability, and ease of installation, they are highly recommended for domestic, commercial, and agricultural applications. They are ideal for automatic water distribution alongside pressure tanks, irrigation systems, and more.

### APPLICATION LIMITS

- Liquid temperature up to **+35 °C**
- Maximum sand content **200 g/m<sup>3</sup>**
- Capable of operating at depths of up to **100 metres** below water level (with an appropriately sized power cable)
- Vertical and horizontal operation
- Starts per hour: **20** at regular intervals

### AVAILABLE UPON REQUEST

- ※ **30 metres** long power cable
- ※ Different voltage requirements 60 Hz frequency

**PERFORMANCE RANGE**

**50 Hz**

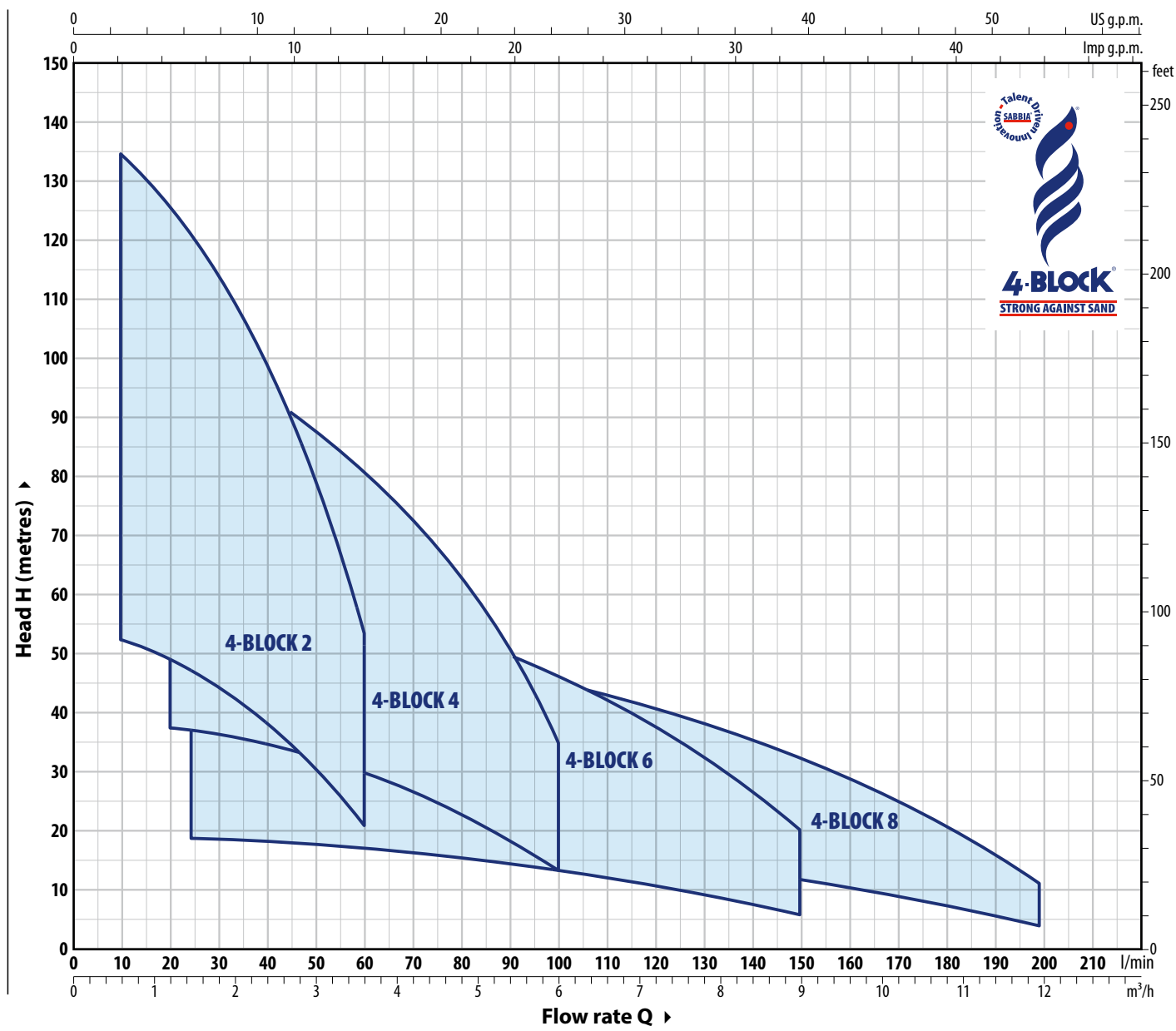

**PATENTS - TRADE MARKS - MODELS**

- European Patents No. EP3123031, EP2419642
- Patent No. 102021000030575
- **4-BLOCK**® is a registered trademark No. 018702380



# 4-BLOCK

## 4" Close-coupled electric submersible pumps

PERFORMANCE RANGE

50 Hz

### 4-BLOCK 2

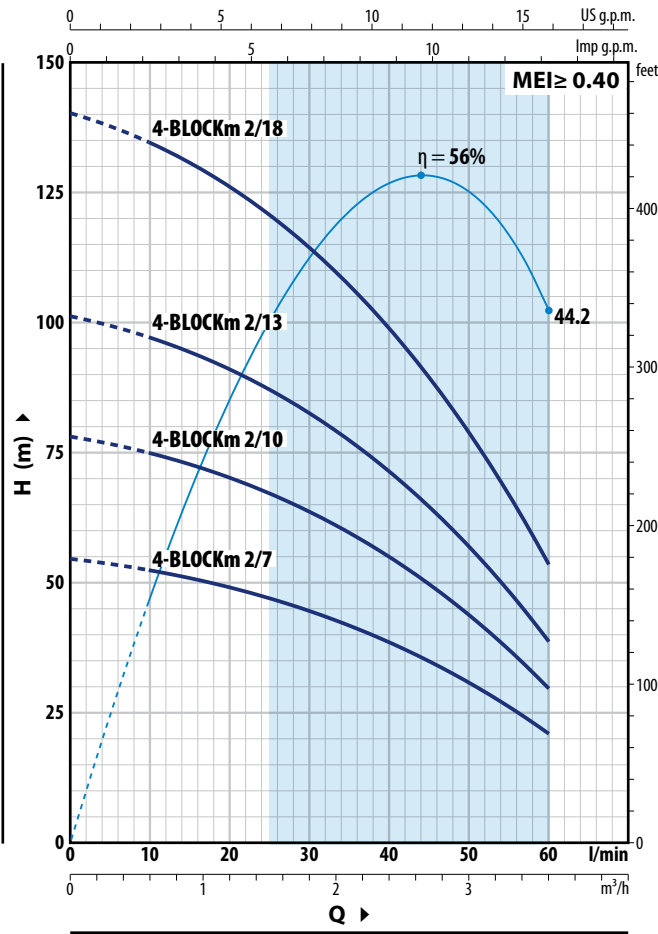

### 4-BLOCK 4

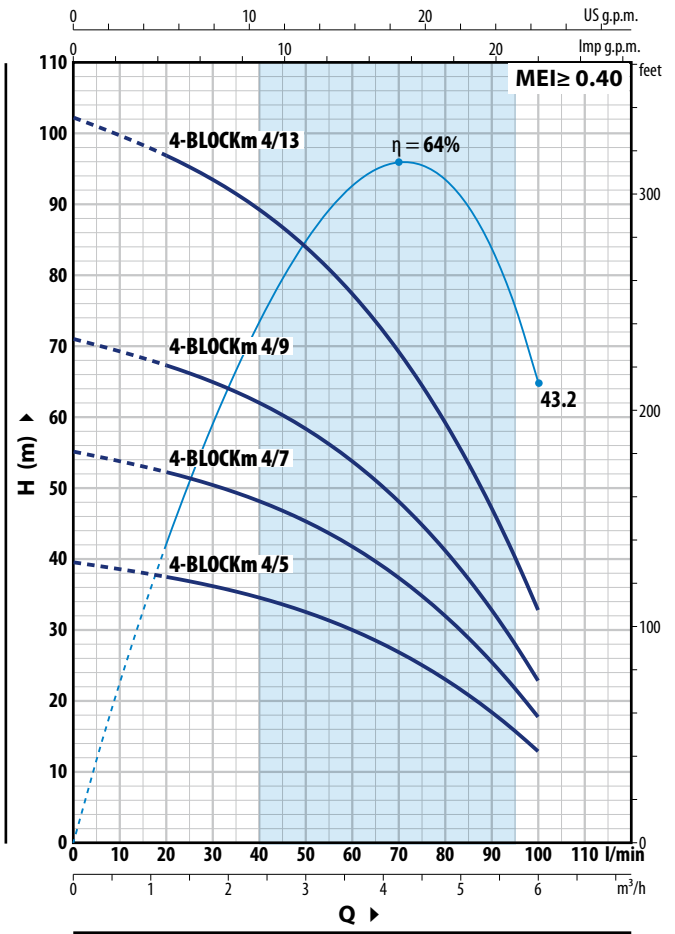

### 4-BLOCK 2

TYPE	POWER (P <sub>2</sub> )		Q	Flow rate (Q)								
	kW	HP		m <sup>3</sup> /h	l/min	0	0.6	1.2	1.8	2.4	3	3.6
Single-phase				<b>0</b>	<b>10</b>	<b>20</b>	<b>30</b>	<b>40</b>	<b>50</b>	<b>60</b>		
4-BLOCKm 2/7	0.37	0.50	H metres	54.5	52.5	49	44.5	38.5	30.5	21		
4-BLOCKm 2/10	0.55	0.75		78	75	70	63.5	55	44	29.5		
4-BLOCKm 2/13	0.75	1		101	97	91	83	71	57	38.5		
4-BLOCKm 2/18	1.1	1.5		140	135	126	114	99	79	53.5		

### 4-BLOCK 4

TYPE	POWER (P <sub>2</sub> )		Q	Flow rate (Q)								
	kW	HP		m <sup>3</sup> /h	l/min	0	1.2	1.5	2.4	3.6	4.5	6
Single-phase				<b>0</b>	<b>20</b>	<b>25</b>	<b>40</b>	<b>60</b>	<b>75</b>	<b>100</b>		
4-BLOCKm 4/5	0.37	0.50	H metres	39.5	37.5	36.5	34.5	30	24.8	12.5		
4-BLOCKm 4/7	0.55	0.75		55	52	51.5	48	41.5	34.5	17.5		
4-BLOCKm 4/9	0.75	1		71	67	66	62	53.5	44.5	22.5		
4-BLOCKm 4/13	1.1	1.5		102	97	95	89	77	64.5	32.5		

Q = Flow rate H = Total manometric head

Performance curves comply with EN ISO 9906 Grade 3B tolerance limits.

PERFORMANCE RANGE

50 Hz

4-BLOCK 6

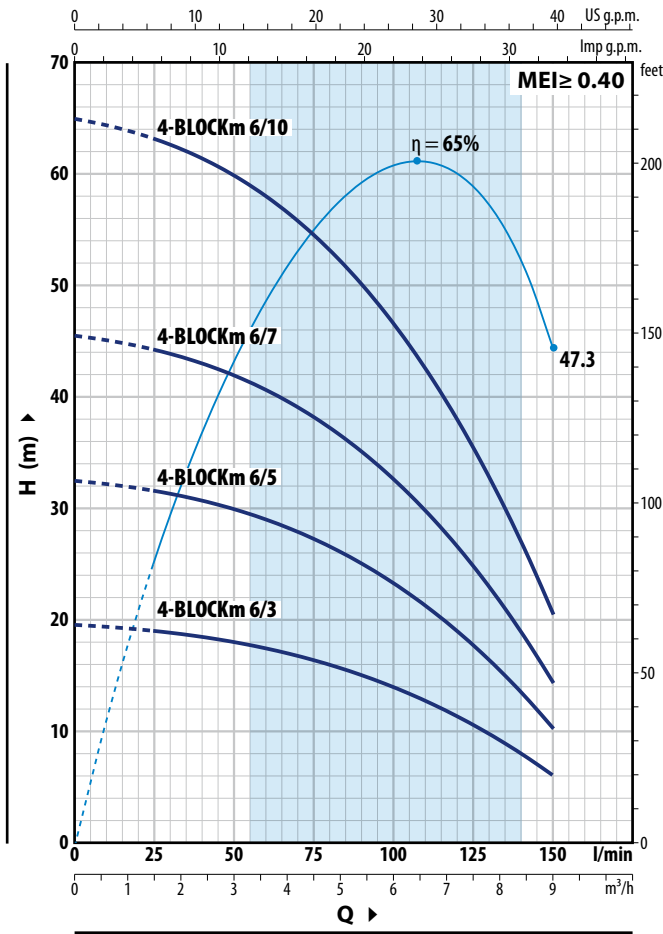

4-BLOCK 8

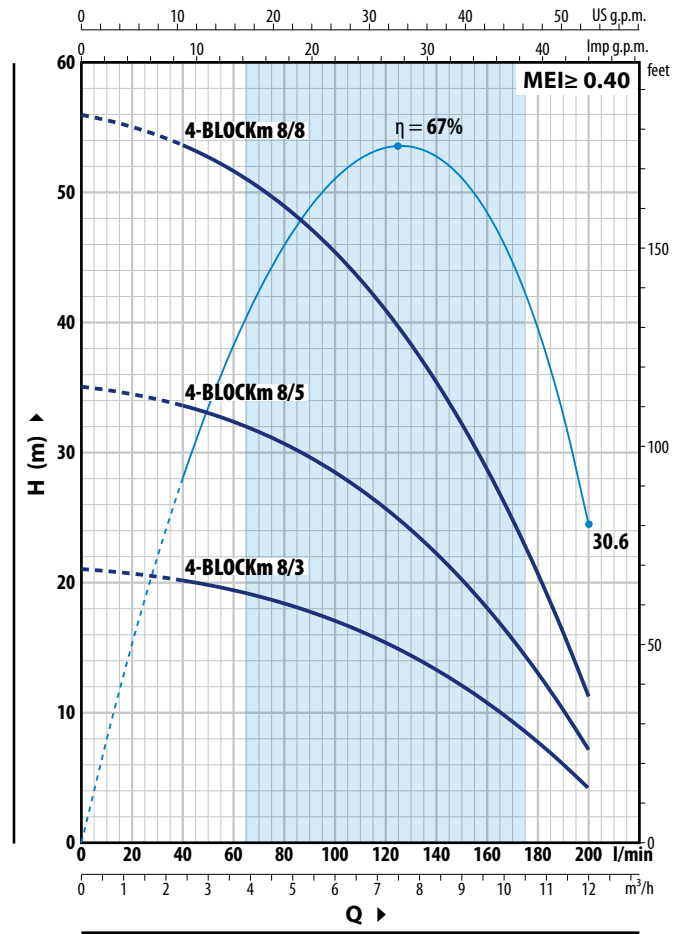

4-BLOCK 6

TYPE	POWER (P <sub>2</sub> )		Q	Flow rate									
	kW	HP		m <sup>3</sup> /h	l/min	0	1.5	2.4	3.6	4.5	6.0	7.5	9.0
Single-phase				0	25	40	60	75	100	125	150		
4-BLOCKm 6/3	0.37	0.50	H metres	19.5	19	18.4	17.4	16.4	14	10.6	6		
4-BLOCKm 6/5	0.55	0.75		32.5	31.5	30.5	29	27.5	23.3	17.7	10		
4-BLOCKm 6/7	0.75	1		45.5	44	43	40.5	38	32.5	24.8	14.5		
4-BLOCKm 6/10	1.1	1.5		65	63	61.5	58	54.5	46.5	35.5	20.5		

4-BLOCK 8

TYPE	POWER (P <sub>2</sub> )		Q	Flow rate									
	kW	HP		m <sup>3</sup> /h	l/min	0	2.4	3.6	4.5	6.0	7.5	9.0	10.5
Single-phase				0	40	60	75	100	125	150	175	200	
4-BLOCKm 8/3	0.55	0.75	H metres	21	20	19.4	18.7	17.1	14.9	12.1	8.6	4	
4-BLOCKm 8/5	0.75	1		35	33.5	32.5	31	28.5	24.8	20.2	14.3	7	
4-BLOCKm 8/8	1.1	1.5		56	53.5	51.5	50	45.5	39.5	32.5	22.9	11.5	

Q = Flow rate H = Total manometric head

Performance curves comply with EN ISO 9906 Grade 3B tolerance limits.

### MATERIALS AND COMPONENTS

<b>1 Delivery port and pump jacket</b>	Stainless steel <b>AISI 304</b> with thread according to ISO 228/1	
<b>2 Pump bearing</b>	EPDM	
<b>3 Impellers</b>	Delrin®	
<b>4 Diffusers</b>	Noryl™	
<b>5 Stadium boxes</b>	Stainless steel <b>AISI 304</b>	
<b>6 Pump shaft</b>	Stainless steel <b>AISI 304</b>	
<b>7 Cable sheath</b>	Stainless steel <b>AISI 304</b>	
<b>8 Filter</b>	Stainless steel <b>AISI 304</b>	
<b>9 Coupling motor bracket</b>	Technopolymer and brass	
<b>10 Motor shaft</b>	Stainless steel <b>AISI 431</b>	
<b>11 Motor sleeve</b>	Stainless steel <b>AISI 304</b>	
<b>12 Mechanical seal</b>	Seal	Shaft
	<b>ST4-16</b>	Ø 16 mm
		Ceramic / Graphite / NBR
<b>13 Capacitor</b>		
<b>14 Electric motor</b>	<ul style="list-style-type: none"> <li>- Specially dimensioned submersible rewindable oil filled motor, suitable for continuous service (non-toxic food-safe oil).</li> <li>- Single-phase 220-230 V - 50 Hz</li> <li>- Built-in motor capacitor</li> <li>- Thermal motor protection incorporated in the winding</li> <li>- Continuous running duty S1</li> <li>- Insulation: Class F</li> <li>- Protection rating: IP X8</li> </ul>	
<b>15 Compensating diaphragm</b>		
<b>16 Power cord</b>	<p>➡ <b>DRINCABLE® HRC</b> certified for use with drinking water meant for human consumption by the <b>ACS</b> according to XP P 41-250, approval no. 18 MAT NY 156</p> <p>Standard length <b>20 metres</b></p>	

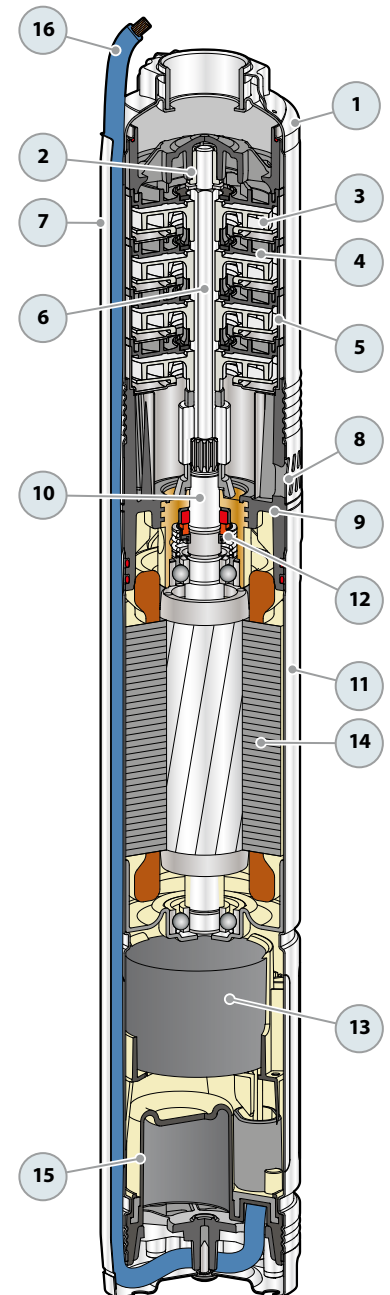

## DIMENSIONS AND WEIGHT

TYPE	PORT DN	DIMENSIONS mm			kg
		NO. STAGES	Ø	h	
<b>Single-phase</b>					1~
4-BLOCKm 2/7	1¼"	7	100	617	11.4
4-BLOCKm 2/10		10		677	12.3
4-BLOCKm 2/13		13		757	13.9
4-BLOCKm 2/18		18		907	17.0
4-BLOCKm 4/5		5		602	11.5
4-BLOCKm 4/7		7		652	12.1
4-BLOCKm 4/9		9		722	13.3
4-BLOCKm 4/13		13		872	16.4
4-BLOCKm 6/3		3		572	11.4
4-BLOCKm 6/5		5		635	12.0
4-BLOCKm 6/7		7		718	13.2
4-BLOCKm 6/10		10		862	16.4
4-BLOCKm 8/3		3		572	12.0
4-BLOCKm 8/5		5		655	12.6
4-BLOCKm 8/8		8		799	15.8

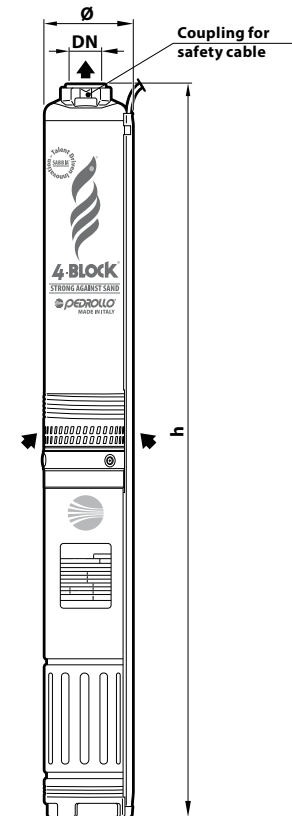

## ABSORPTION

TYPE	VOLTAGE
<b>Single-phase</b>	<b>230 V</b>
4-BLOCKm – 0.37 kW	3.5 A
4-BLOCKm – 0.55 kW	4.4 A
4-BLOCKm – 0.75 kW	6.1 A
4-BLOCKm – 1.1 kW	8.0 A

## PALLET CAPACITY

TYPE	NO. OF PUMPS
<b>Single-phase</b>	
4-BLOCKm 2	55
4-BLOCKm 4	55
4-BLOCKm 6	55
4-BLOCKm 8	55

## Typical installation

