

# XST (<7.5 kW) Standardized centrifugal pump in cast iron (<7.5 kW)

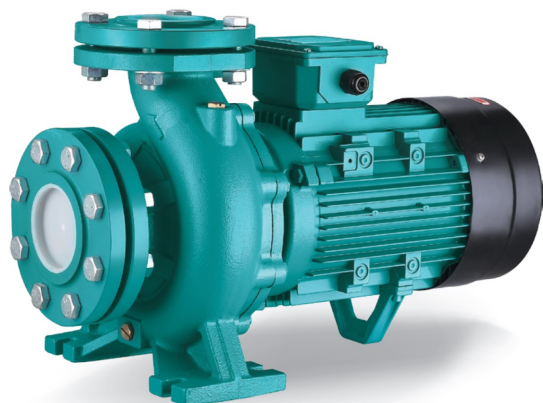

## Application

- Transfer of clear water or other liquids chemically and physically comparable to water
- Water supply and irrigation
- Water circulation in air conditioning systems

## Pompe

- Single-stage centrifugal pump
- Flow up to 220 m<sup>3</sup>/h
- HMT up to 95 m
- Liquid temperature between -10°C and 85°C
- Maximum operating pressure of 12 bars
- Stainless steel impeller AISI304 (models XST32, XST40-200) or HT200
- Mechanical seal in accordance with DIN 24960
- Standardized centrifugal pumps according to EN 733

## Moteur

- Insulation class: F
- Protection class: IP54
- Performances in accordance with CEI 2-3 (IEC 34.1)
- Maximum ambient temperature: +40°C

## Identification codes

**XST m 32 -125 /11**

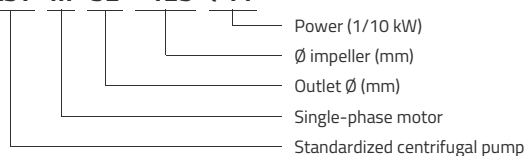

## Technical data

MODEL	kW	Q (m <sup>3</sup> /h) Q (l/min)	0	6	9	15	18	24	27	36	42	48	54	72	84	90	108	120
			0	100	150	250	300	400	450	600	700	800	900	1200	1400	1500	1800	2000
XSTm32-125/7	0.75		17.5	16.7	15	12	9											
XST32-125/7	0.75		17.5	16.7	15	12	9											
XSTm32-125/11	1.1		22	21	20.2	17	15	9										
XST32-125/11	1.1		22	21	20.2	17	15	9										
XSTm32-160/15	1.5		24	23.7	22.5	19.5	16.2											
XST32-160/15	1.5		24	23.7	22.5	19.5	16.2											
XSTm32-160/22	2.2		31	29.6	29	25.5	22.5	15										
XST32-160/22	2.2		31	29.6	29	25.5	22.5	15										
XSTm32-160/30	3		34.5	33.5	33	29	26.5	20	16.5									
XST32-160/30	3		34.5	33.5	33	29	26.5	20	16.5									
XST32-200/30	3		43.2	42	40.5	35.2	32.2	24.6	19.8									
XST32-200/40	4		52	50.5	50	45	41.9	35	30.3									
XST32-250/55	5.5		79	74.7	71.8	63	56	37.5										
XST32-250/75	7.5		95	92	89	82	75	57.8										
XSTm40-125/11	1.1		14.7				13	11.5	10.1									
XST40-125/11	1.1		14.7				13	11.5	10.1									
XSTm40-125/15	1.5		18.1				17	15	13.9									
XST40-125/15	1.5		18.1				17	15	13.9									
XSTm40-125/22	2.2		24.5				23.2	21.5	20.2	16	12							
XST40-125/22	2.2		24.5				23.2	21.5	20.2	16	12							
XST40-160/30	3		31.8				29	27.5	26.3	21.5	17.5							
XST40-160/40	4		38				36	34	33	28.5	25	20.1						
XST40-200/55	5.5		44				42	40	38	32	27							
XST40-200/75	7.5		55				52	49	48	42	37	32						
XSTm50-125/22	2.2		17							15.4	14	12.8	11.5					
XST50-125/22	2.2		17							15.4	14	12.8	11.5					
XST50-125/30	3		20							18.8	18	17	15.6					
XST50-125/40	4		24							23.1	22.6	21.5	20.3	15.8				
XST50-160/55	5.5		32							30.6	30	28	26.6	20.5				
XST50-160/75	7.5		40							38	37	36	34.4	29				
XST65-125/40	4		19									17.3	16.8	14.5	13	11.8		
XST65-125/55	5.5		23									21.3	20.9	19	17.5	16.7	13.7	
XST65-125/75	7.5		27									26	25.6	24.5	23	22.5	20	18

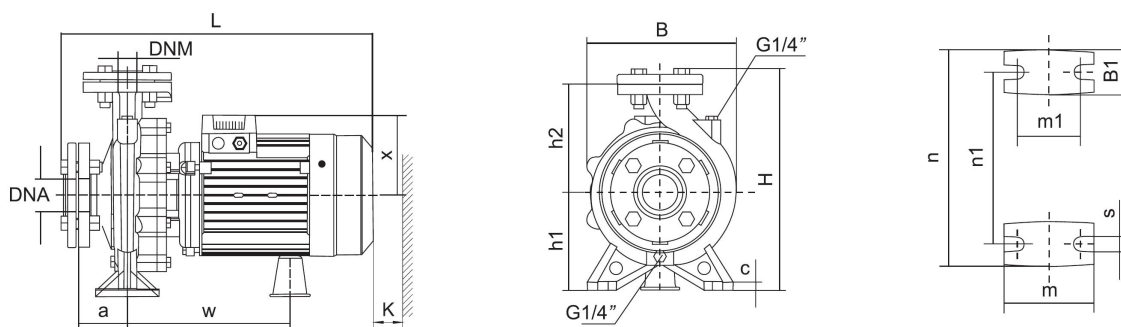

MODEL	DNM	DNA	a	w	x	h2	B1	c	h1	m	m1	n	n1	s	B	H	L	K
XSTm32-125/7	32	50	80	223	113	140	48	12	112	100	70	190	140	15	192	281	427	85
XST32-125/7	32	50	80	223	113	140	48	12	112	100	70	190	140	15	192	281	427	85
XSTm32-125/11	32	50	80	223	113	140	48	12	112	100	70	190	140	15	192	281	427	85
XST32-125/11	32	50	80	223	113	140	48	12	112	100	70	190	140	15	192	281	427	85
XSTm32-160/15	32	50	80	231	123	160	50	16	132	100	70	240	190	14	240	321	430	95
XST32-160/15	32	50	80	231	123	160	50	16	132	100	70	240	190	14	240	321	430	95
XSTm32-160/22	32	50	80	231	123	160	50	16	132	100	70	240	190	14	240	321	430	95
XST32-160/22	32	50	80	231	123	160	50	16	132	100	70	240	190	14	240	321	430	95
XSTm32-160/30	32	50	80	266	141	160	50	16	132	100	70	240	190	14	240	321	496	95
XST32-160/30	32	50	80	266	141	160	50	16	132	100	70	240	190	14	240	321	496	95
XST32-200/30	32	50	80	258	127	180	48	12	160	100	70	240	190	15	248	369	490	95
XST32-200/40	32	50	80	258	127	180	48	12	160	100	70	240	190	15	248	369	490	95
XST32-250/55	32	50	155	264	180	198	60	15	160	100	70	272	212	15	308	386	610	60
XST32-250/75	32	50	155	264	180	198	60	15	160	100	70	272	212	15	308	386	640	60
XSTm40-125/11	40	65	80	255	127	140	45	12	112	100	70	210	160	15	218	282	489	95
XST40-125/11	40	65	80	255	127	140	45	12	112	100	70	210	160	15	218	282	489	95
XSTm40-125/15	40	65	80	255	127	140	45	12	112	100	70	210	160	15	218	282	489	95
XST40-125/15	40	65	80	255	127	140	45	12	112	100	70	210	160	15	218	282	489	95
XSTm40-125/22	40	65	80	255	127	140	45	12	112	100	70	210	160	15	218	282	489	95
XST40-125/22	40	65	80	255	127	140	45	12	112	100	70	210	160	15	218	282	489	95
XST40-160/30	40	65	80	238	127	168	48	12	132	100	70	240	190	15	249	330	494	105
XST40-160/40	40	65	80	238	127	168	48	12	132	100	70	240	190	15	249	330	494	105
XST40-200/55	40	65	100	259	180	180	50	12	160	100	70	264	212	15	275	370	553	105
XST40-200/75	40	65	100	259	180	180	50	12	160	100	70	264	212	15	275	370	583	105
XSTm50-125/22	50	65	100	262	127	160	50	12	132	100	70	240	190	15	243	322	518	110
XST50-125/22	50	65	100	262	127	160	50	12	132	100	70	240	190	15	243	322	518	110
XST50-125/30	50	65	100	262	127	160	50	12	132	100	70	240	190	15	243	322	518	110
XST50-125/40	50	65	100	262	127	160	50	12	132	100	70	240	190	15	243	322	518	110
XST50-160/55	50	65	100	262	180	180	52	12	160	100	70	264	212	15	272	370	556	110
XST50-160/75	50	65	100	262	180	180	52	12	160	100	70	264	212	15	272	370	586	110
XST65-125/40	65	80	100	265	180	180	68	14	160	125	95	280	212	15	283	372	564	110
XST65-125/55	65	80	100	265	180	180	68	14	160	125	95	280	212	15	283	372	564	110
XST65-125/75	65	80	100	265	180	180	68	14	160	125	95	280	212	15	283	372	594	110

## Exploded view

No.	Type	Materials
1	Backing flange	cast iron HT200
2	Pump body	cast iron HT200
3	Impeller	stainless steel AISI 304 / cast iron HT200
4	Mechanical seal	carbon / ceramic
5	O-ring	nitrile rubber (NBR)
6	Pump bottom	cast iron HT200
7	Fan cover	08F steel
8	Fan	polypropylene
9	Rear cover	cast aluminum ZL102
10	Leg	cast iron HT200
11	Stator	
12	Bearing	
13	Rotor	
14	Bearing	
15	Oil seal	

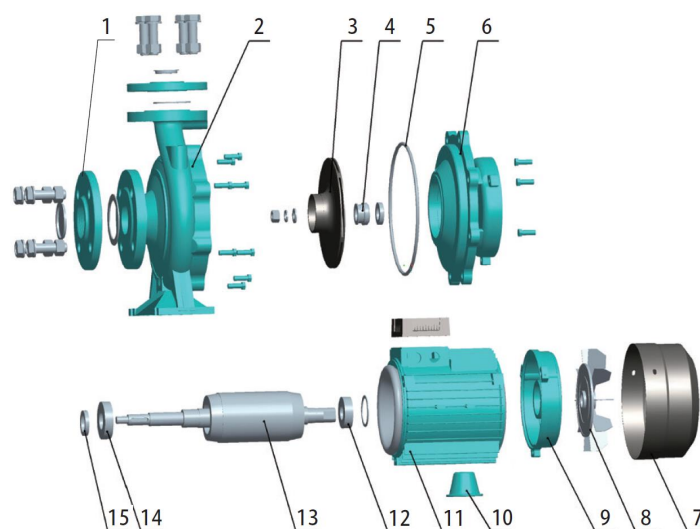

XST(m)32-125      ~2900rpm      ISO 9906 Annex A

Total manometric height (m)

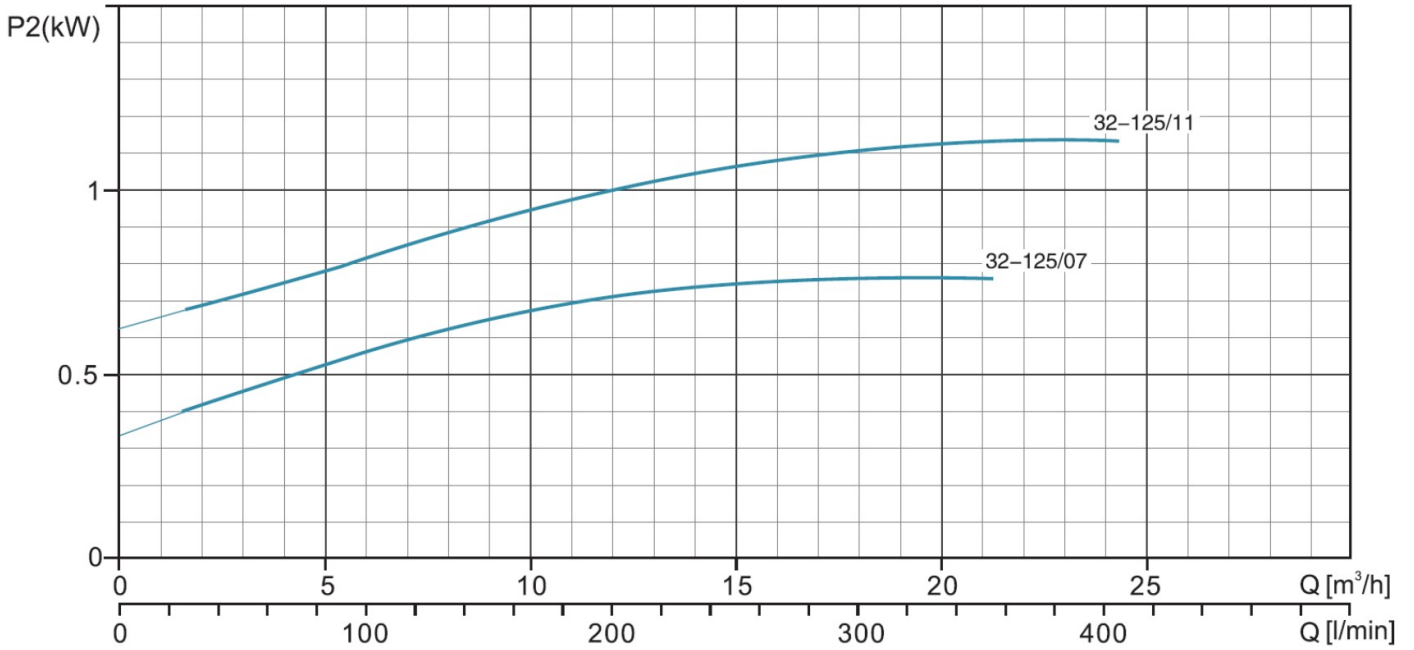
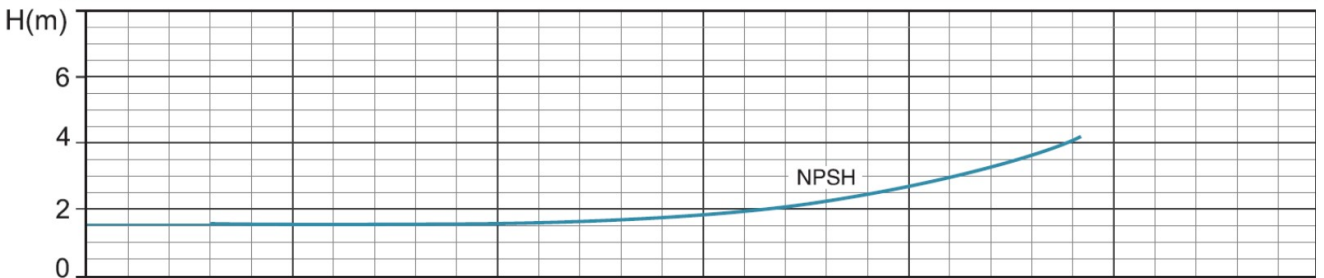
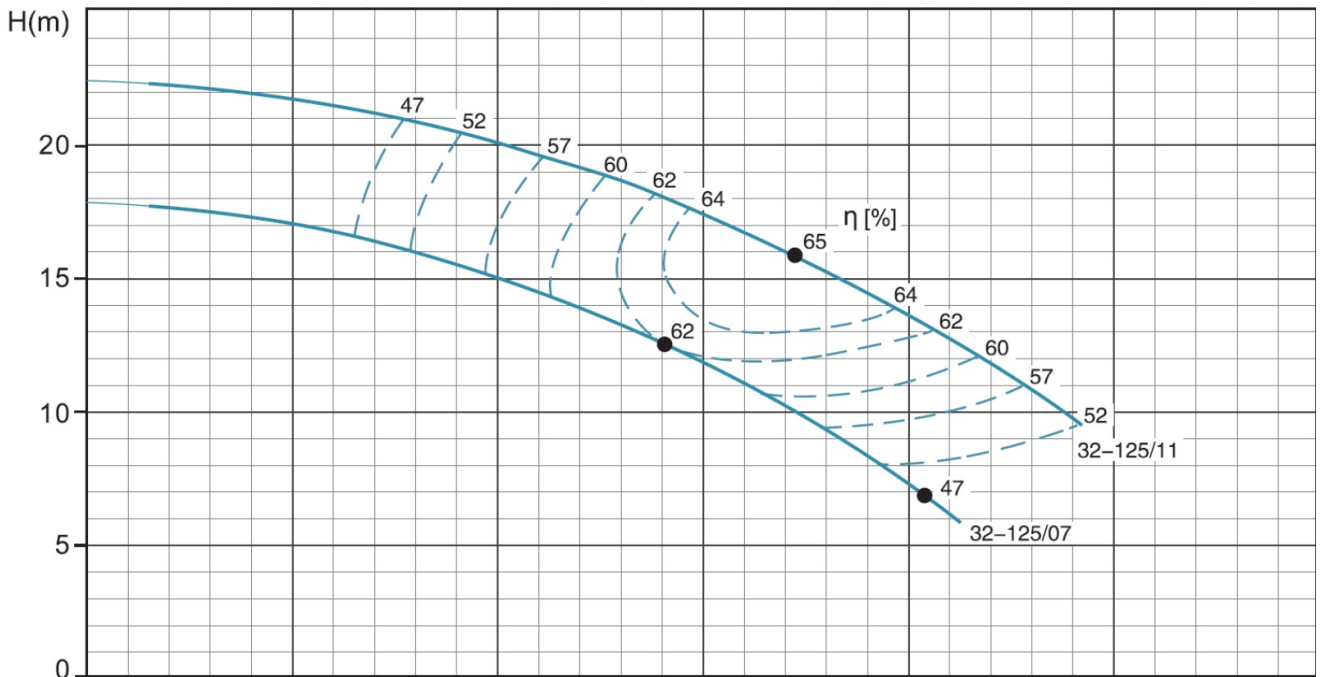

XST(m)32-160      ~2900rpm      ISO 9906 Annex A

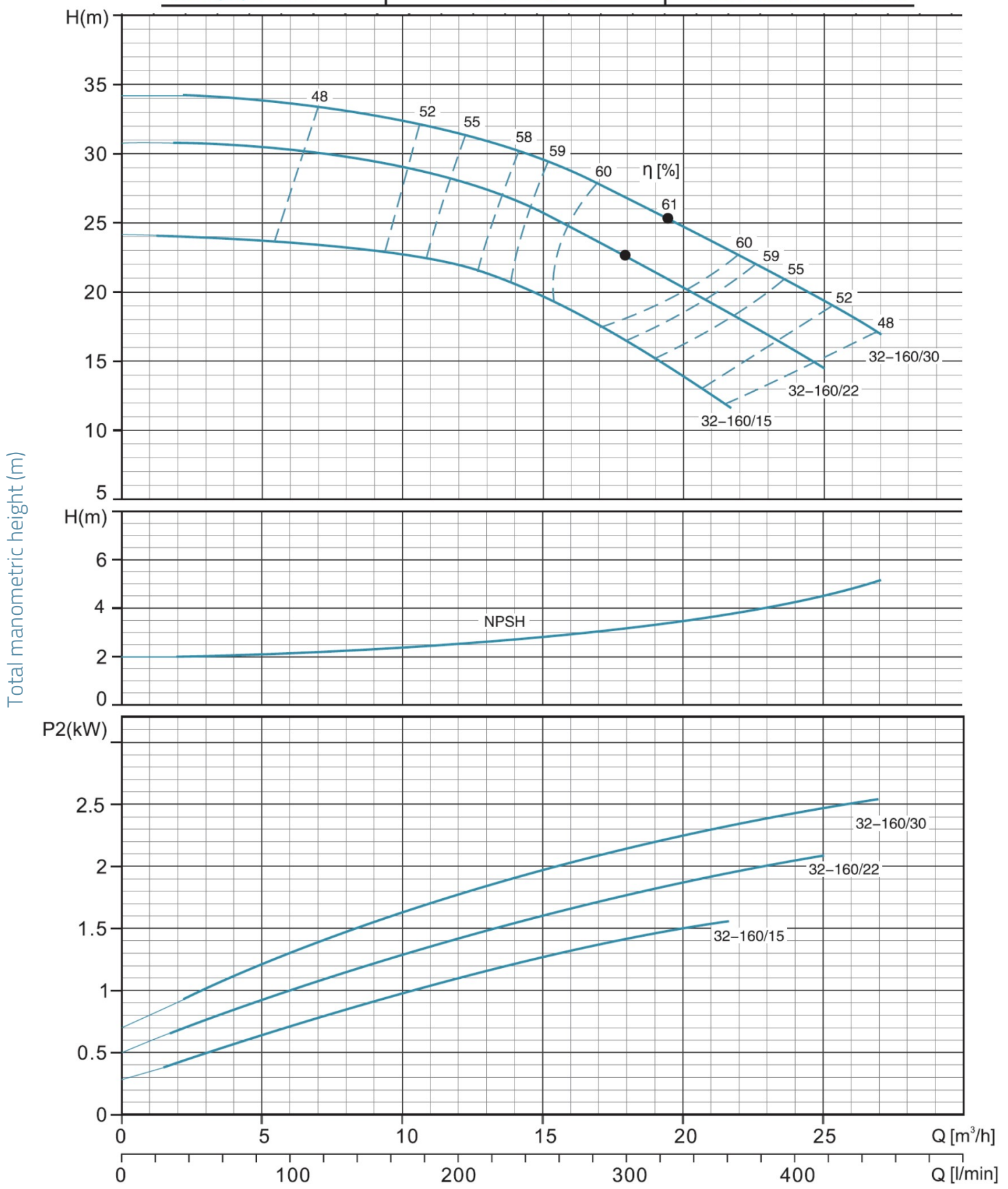

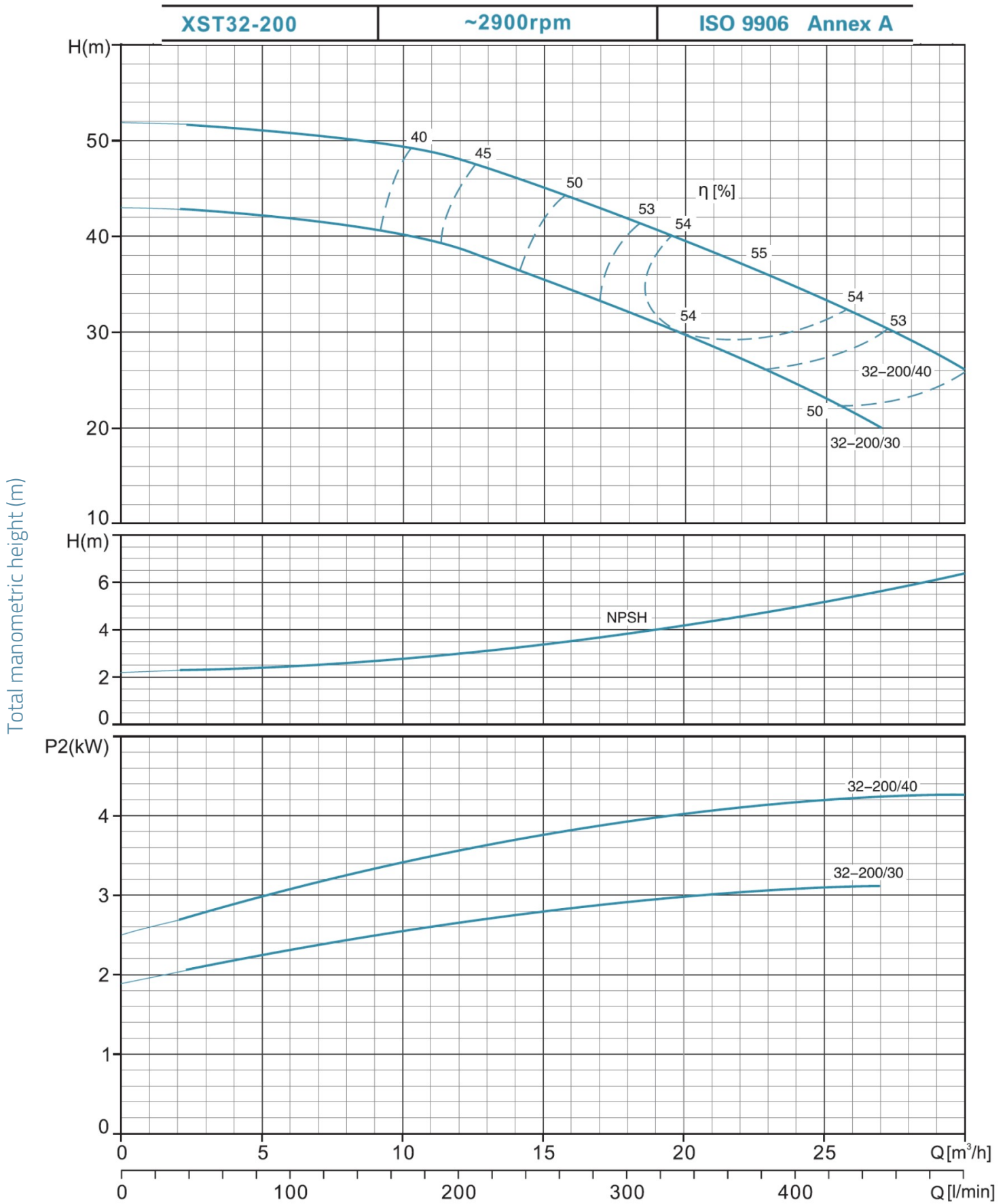

**XST32-250**      **~2900rpm**      **ISO 9906 Annex A**

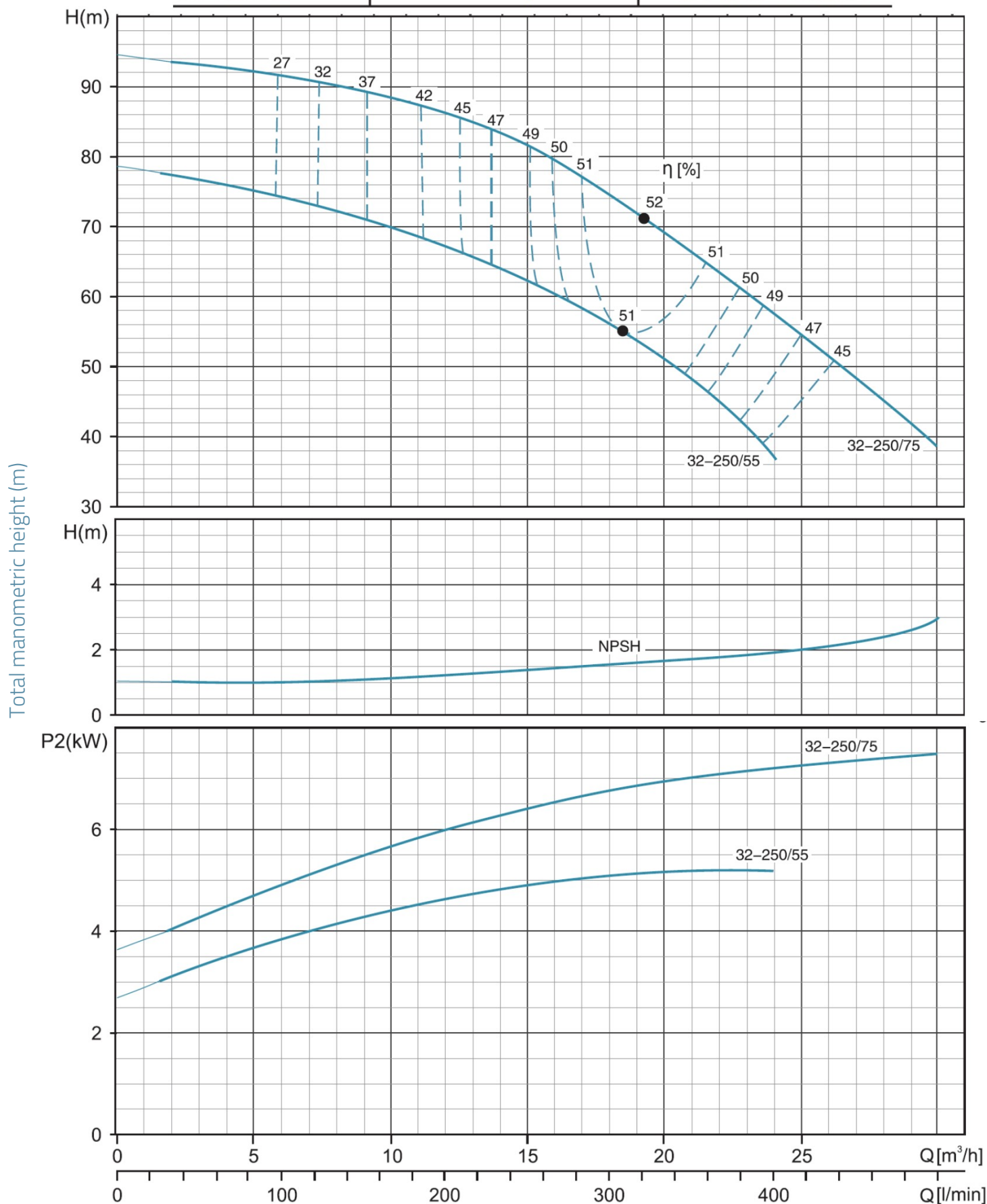

# Hydraulic performance

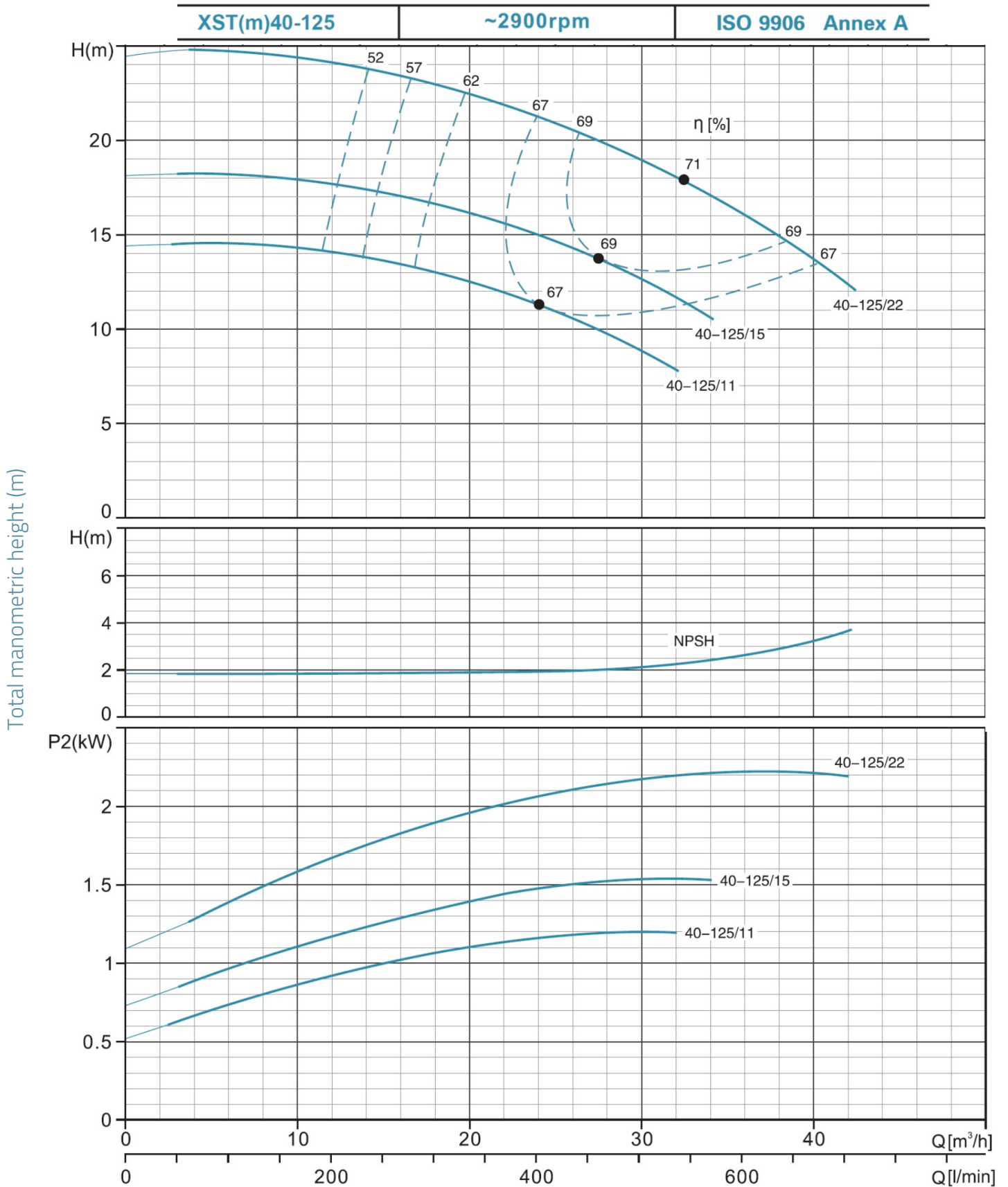

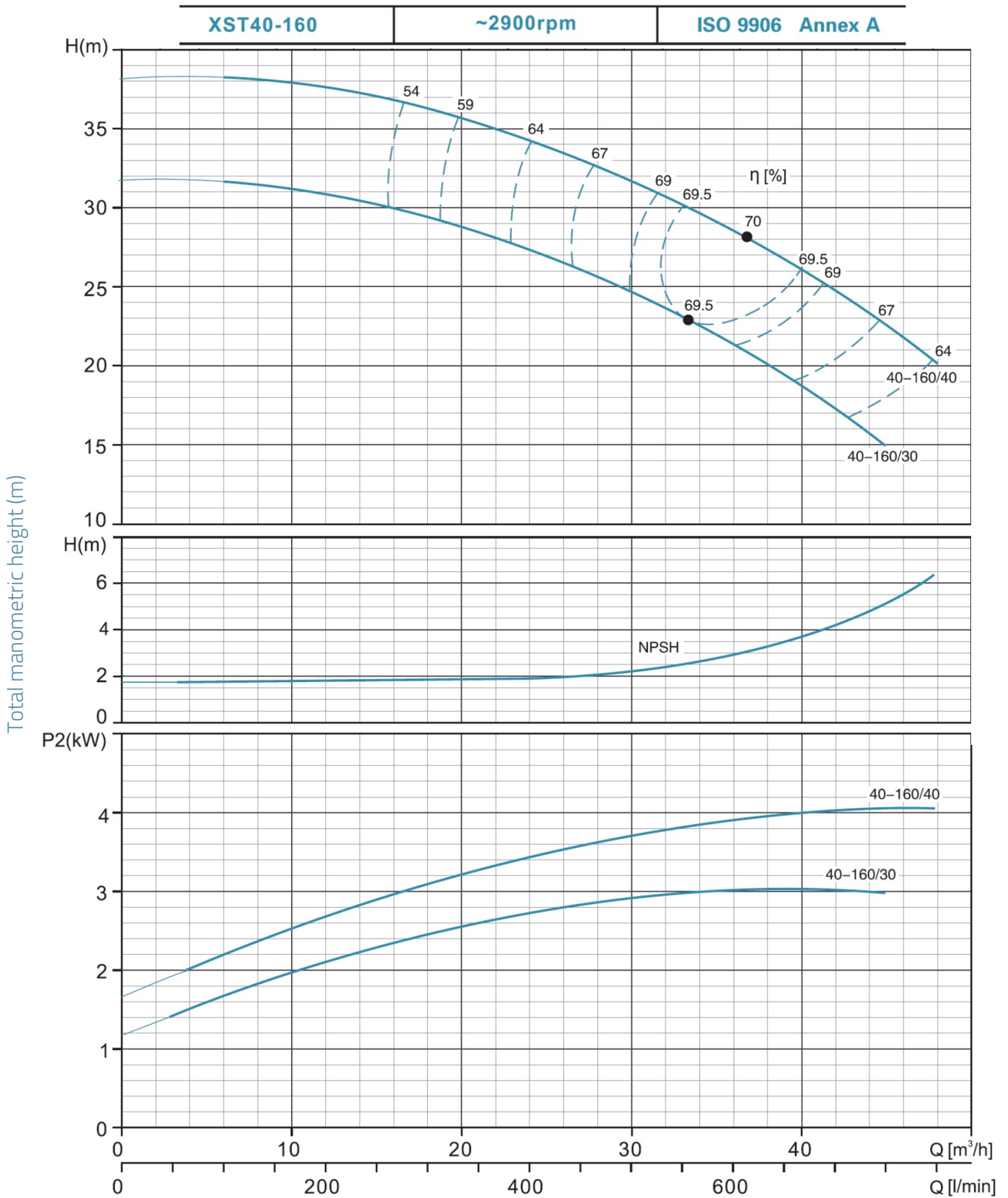



# Hydraulic performance

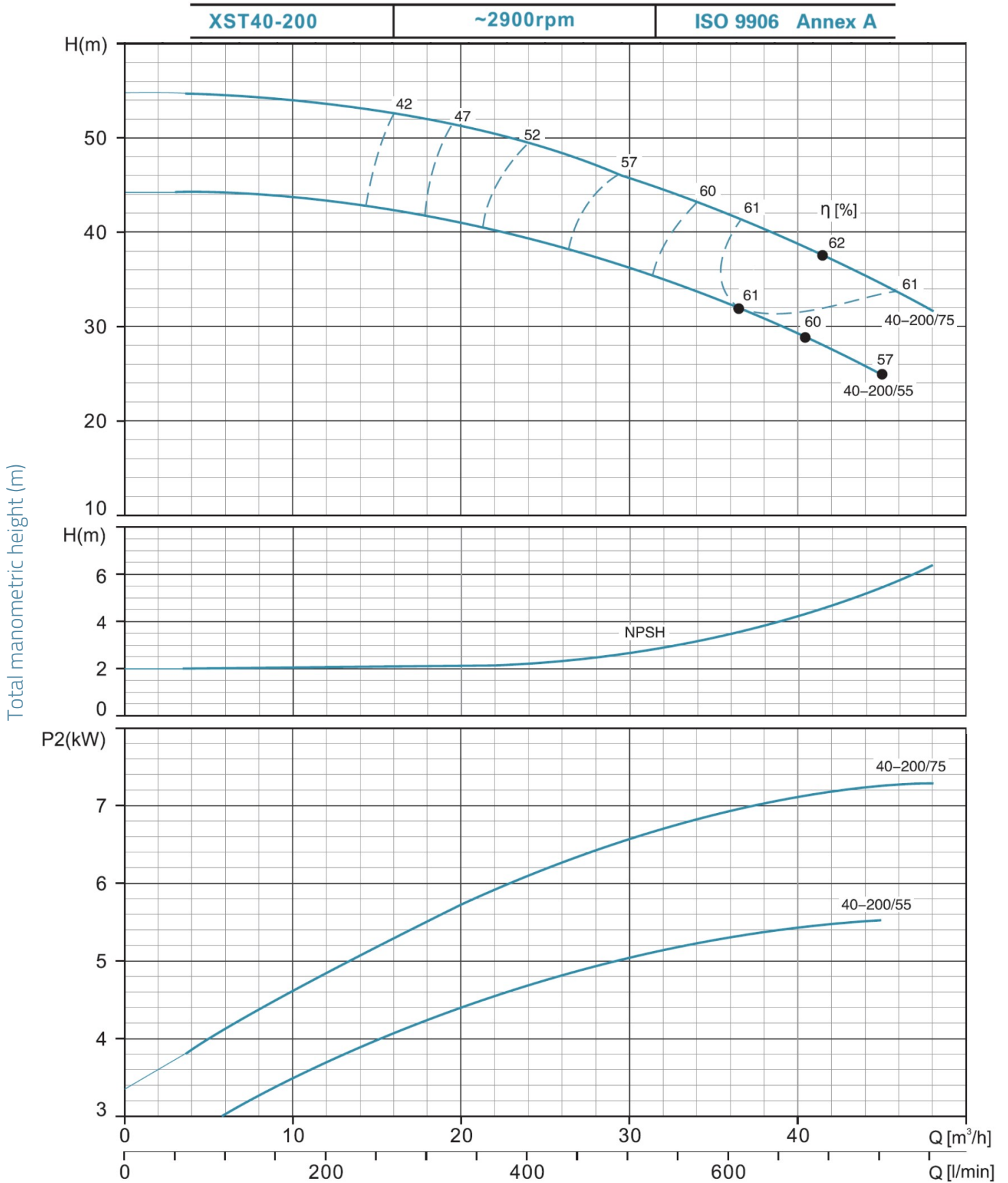

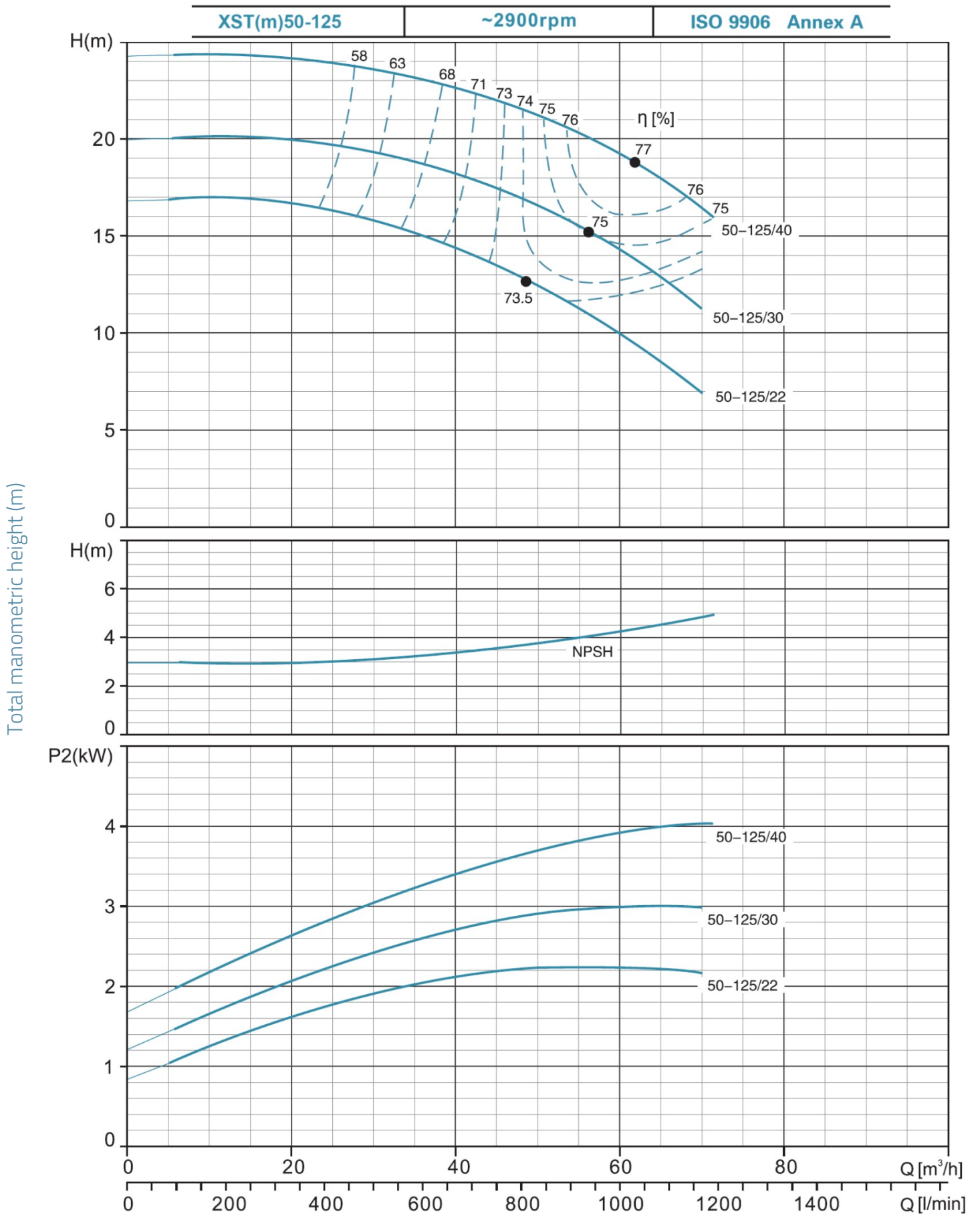

XST50-160      ~2900rpm      ISO 9906 Annex A

Total manometric height (m)

