

FTR/FTRT

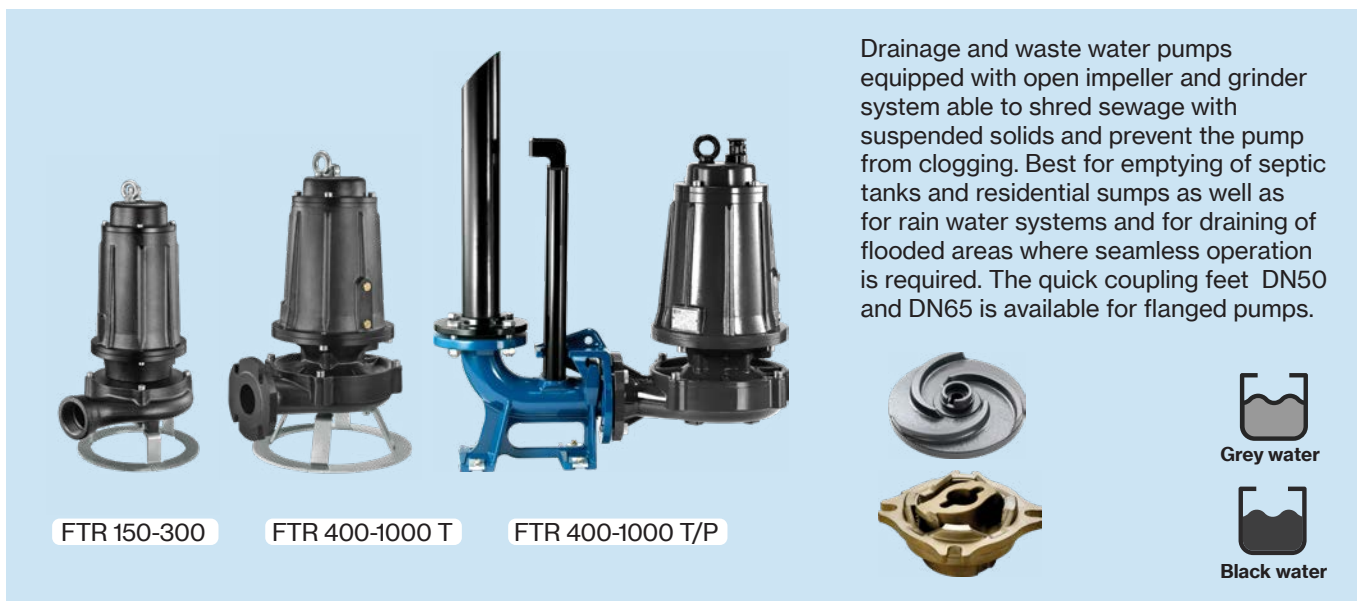

Drainage and waste water pumps equipped with open impeller and grinder system able to shred sewage with suspended solids and prevent the pump from clogging. Best for emptying of septic tanks and residential sumps as well as for rain water systems and for draining of flooded areas where seamless operation is required. The quick coupling feet DN50 and DN65 is available for flanged pumps.

FTR 150-300

FTR 400-1000 T

FTR 400-1000 T/P



Construction features

Painting	cataphoresis
Pump body	cast iron
Impeller	cast iron
Mechanical seal	double seal with oil barrier: silicon carbide on pump side, ceramic-graphite on motor side
Motor shaft	stainless steel AISI 304
Max submergence	20 m
Liquid temperature	0 - 40 °C
	Grinder treated stainless steel
Bolts	A2 stainless steel
Foot support	galvanized iron
Gaskets	NBR rubber

Motor

2 Poles induction motor	3- 230V - 50Hz
	3- 400V - 50Hz
	3- 230/400V - 50Hz
	3- 400/690V - 50Hz
run capacitor (35µF for 1,5HP models, 50µF for 2HP model) + start capacitor (80µF with disjuntor) required	1- 230V - 50Hz
Insulation class	F
Protection degree	IPX8

TYPE	LOTS			
	TRUCK		CONTAINER	
	PALLET (cm)	N° pumps	PALLET (cm)	N° pumps
FTR 150÷300T	85×110×145	18	85×110×190	27
FTR 400-550T	85×110×170	12	85×110×170	12
FTR 1000T	100×120×190	12	100×120×190	12

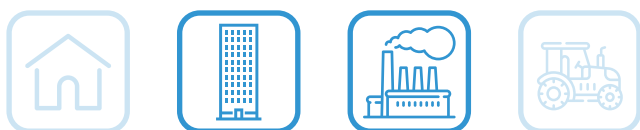
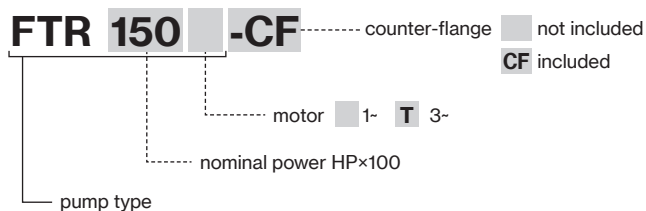

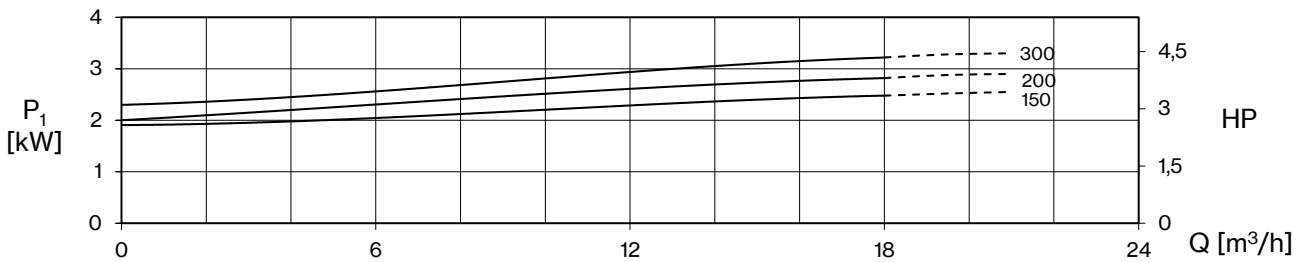
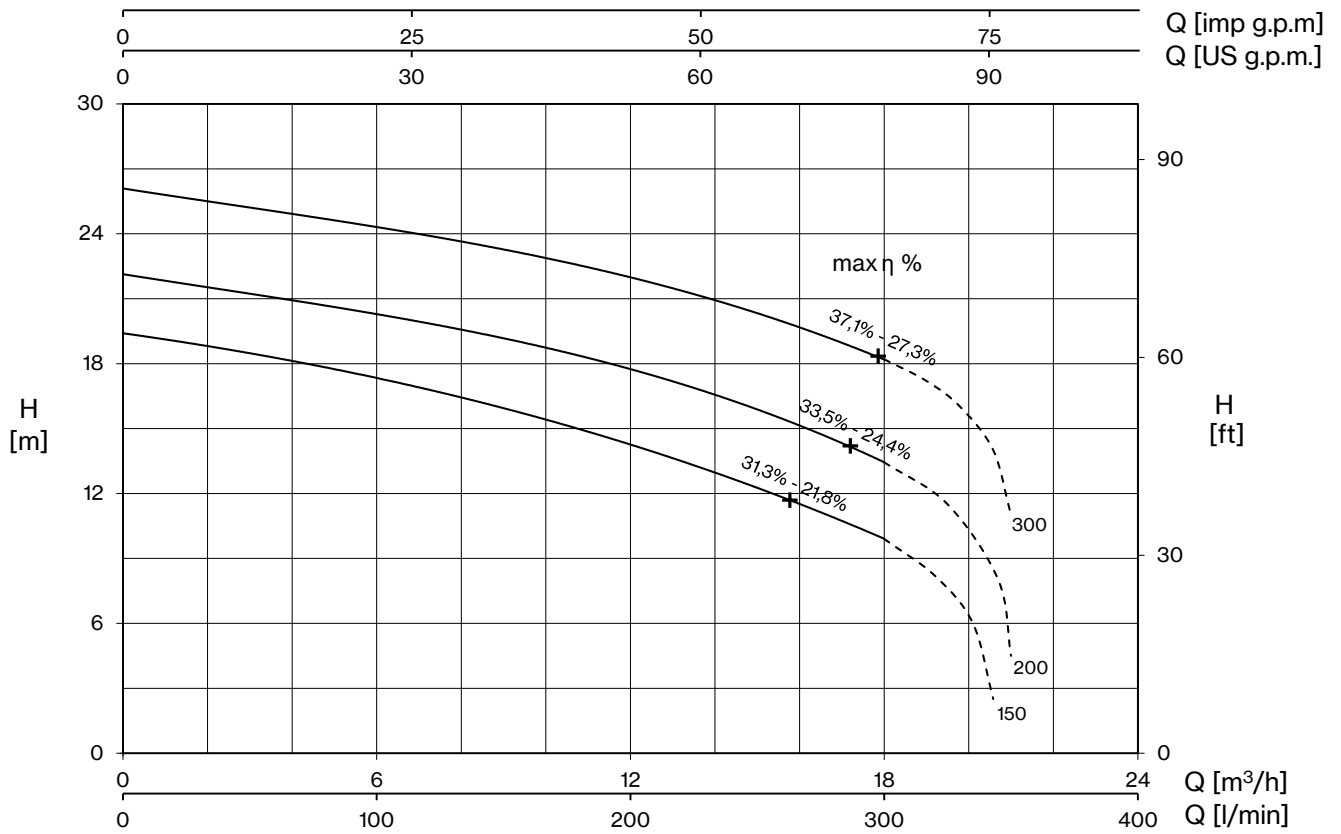

TYPE		AMPERE				
1~	3~	230V 50 Hz	3~ 230V 50 Hz (*)	3~400V 50 Hz	230/400 V 50 Hz λ/Δ (*)	400/690 V 50 Hz λ/Δ
FTR 150	FTR 150T	11,5	7,6	4,4	-	-
FTR 200	FTR 200T	13,6	8,8	5,1	-	-
-	FTR 300T	-	10,0	5,8	-	-

+ max η %

max hydraulic efficiency and respective total efficiency

(*) no standard execution

TYPE		P2		P1 (kW)		Q (m³/h - l/min)							
1~	3~	HP	kW	1~	3~	0	3	6	9	12	13,2	15	18
						0	50	100	150	200	220	250	300
						H (m)							
FTR 150	FTR 150T	1,5	1,1	2,6	2,5	19,4	18,5	17,3	16,0	14,2	13,5	12,3	9,9
FTR 200	FTR 200T	2	1,1	3,0	2,8	22,1	21,3	20,3	19,1	17,7	17,1	16,0	13,4
-	FTR 300T	3	2,2	-	3,2	26,1	25,2	24,3	23,3	22,0	21,4	20,3	18,2

FTR/FTRT

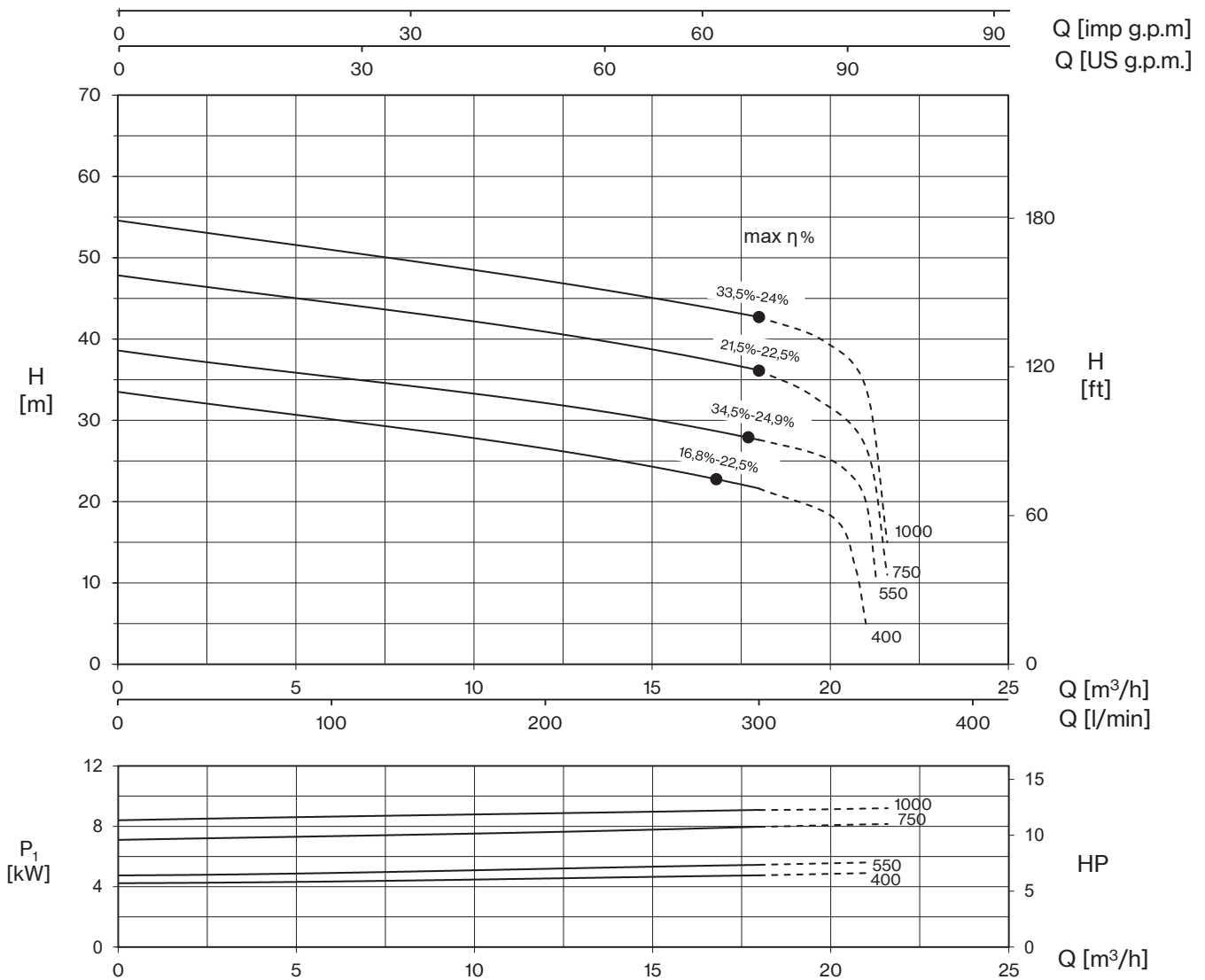

TYPE	AMPERE			
	3~ 230V 50 Hz (*)	3~ 400V 50 Hz	230/400 V 50 Hz λ / Δ (*)	400/690 V 50 Hz λ / Δ
FTR 400T	13,0	7,5	-	-
FTR 550T	15,9	9,2	-	-
FTR 750T	-	13,9	24	13,9
FTR 1000T	-	15,5	26,8	15,5

(*) no standard execution

+ max η %
max hydraulic efficiency and respective total efficiency

TYPE	P2		P1 (kW)	Q (m³/h - l/min)							
				0	3	6	9	12	15	18	
	HP	kW	3~	0	50	100	150	200	250	300	
FTR 400T	4	3	4,5	33,5	31,8	30,1	28,5	26,4	24,4	21,6	
FTR 550T	5,5	4	5,3	38,6	36,9	35,3	33,9	32,1	30,1	27,6	
FTR 750T	7,5	5,5	8,0	47,8	46,2	44,5	42,7	40,8	38,9	36,1	
FTR 1000T	10	7,5	9,1	54,6	52,7	51,0	49,2	47,1	45,1	42,7	



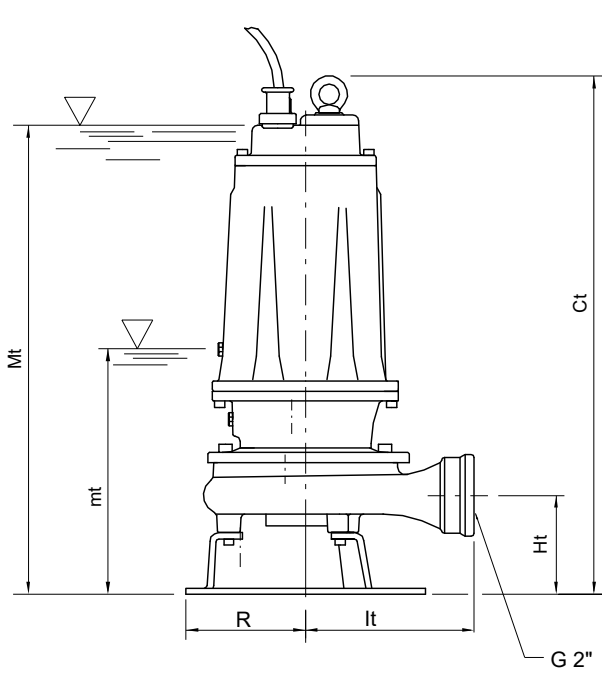

mt: minimum working level
 Mt: minimum submergence level for continuous duty

TYPE	DIMENSIONS (mm)							Kg
	Ct	Ht	R	lt	mt	Mt	DNM	
FTR 150 - FTR 150T	513	102	117	174	205	475	2" G	38
FTR 200 - FTR 200T	513	102	117	174	205	475	2" G	38,5
FTR 300T	513	102	117	174	205	475	2" G	38

TYPE	PROTECTION		1 PUMP CONTROL PANEL			2 PUMPS CONTROL PANEL		
	1- 230V	3- 400V	1- 230V	3- 400V	400/690 V	1- 230V	3- 400V	400/690 V
FTR 150	PMLD 15/35-13	PT 20-30-40/4.3-6.8	EQSM + 35µF + 80µF*	EQSMT 10		EQ2SM + 2×35µF + 2×80µF*	EQ2SMT 10	
FTR 200	PMLD 20/50-15	PT 20-30-40/4.3-6.8	EQSM + 50µF + 80µF*	EQSMT 10		EQ2SM + 2×50µF + 2×80µF*	EQ2SMT 10	
FTR 300T		PT 20-30-40/4.3-6.8		EQSMT 10			EQ2SMT 10	
FTR 400T		PT 40-50/5.7-9.1		EQSMT 10			EQ2SMT 10	
FTR 550T		PT 55-75/8.6-13.5		EQSMT 10			EQ2SMT 10	
FTR 750T		PT 100/12.5-16.5		EQSMT 10	QST 7		EQ2SMT 10	Q2ST 7
FTR 1000T		PT 125-150/16-21		EQSMT 10	QST 10		EQ2SMT 10	Q2ST 10

*start capacitor with disjuntor

