



NMT MINI PRO 25/40-180

979525434

NMT MINI

GENERAL

Product number	979525434		
Product name	NMT MINI PRO 25/40-180	MEI	/
Seal type	/	Energy efficiency index	0.13
Net weight	1.73 kg		
Head max. (H max)	4.3 m	H min	0.0 m
Flow max. (Q max)	3.0 m³/h	Q min	0.0 m³/h
	%		
Noise	≤43 dB(A)		

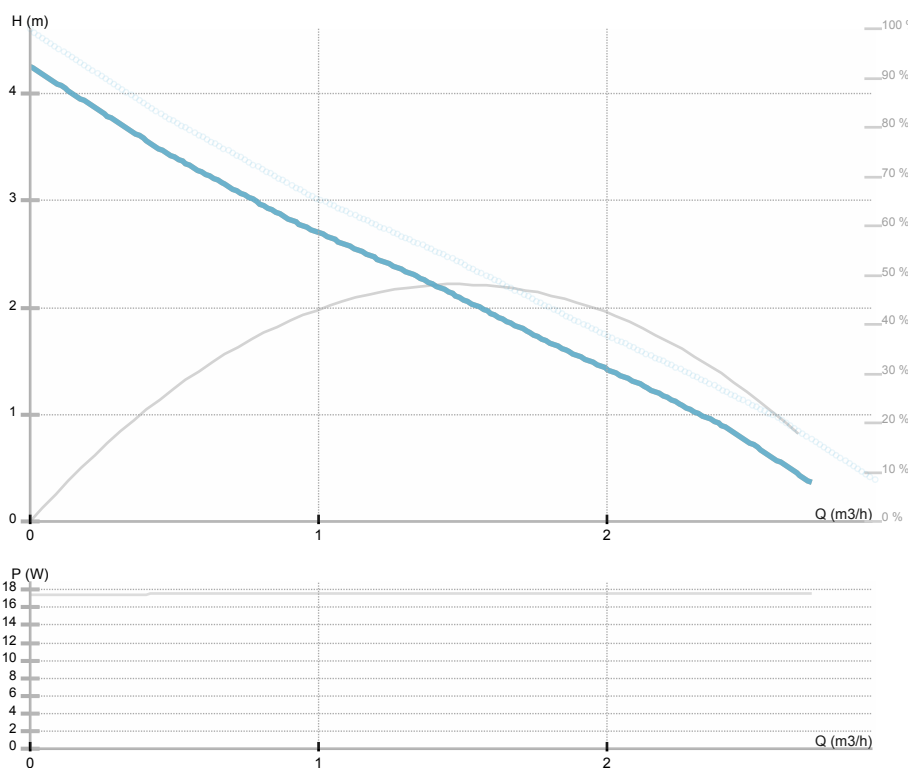

ELECTRICAL DATA

Supply voltage	1~230 V
Mains frequency	50/60 Hz
Power input max.	17 W
Speed max.	4000 rpm
Insulation class	F (155 °C)
Current max.	0.2 A
Protection class	IP44
Thermal protection	NTC
Frame size	
Motor IE class	/

INSTALLATION

Pumped liquid	water VDI 2035, glycol 40%
Liquid temperature	-10.0 ÷ 110.0 °C
Ambient temp.range	40 °C
Port-to-port length	180 mm
Pipe connection	25
Pressure rating	G 1 ½
Connection	G 1 ½
Max operating pressure	1.0 MPa

MATERIAL

Bearing	all carbon
Impeller	Noryl Fe 1630PW
Hydraulics	gray cast iron
Shaft	AISI 420

NMT MINI PRO 25/40-180

979525434

NMT MINI





NMT MINI PRO 25/40-180

979525434

NMT MINI

Dimension drawing

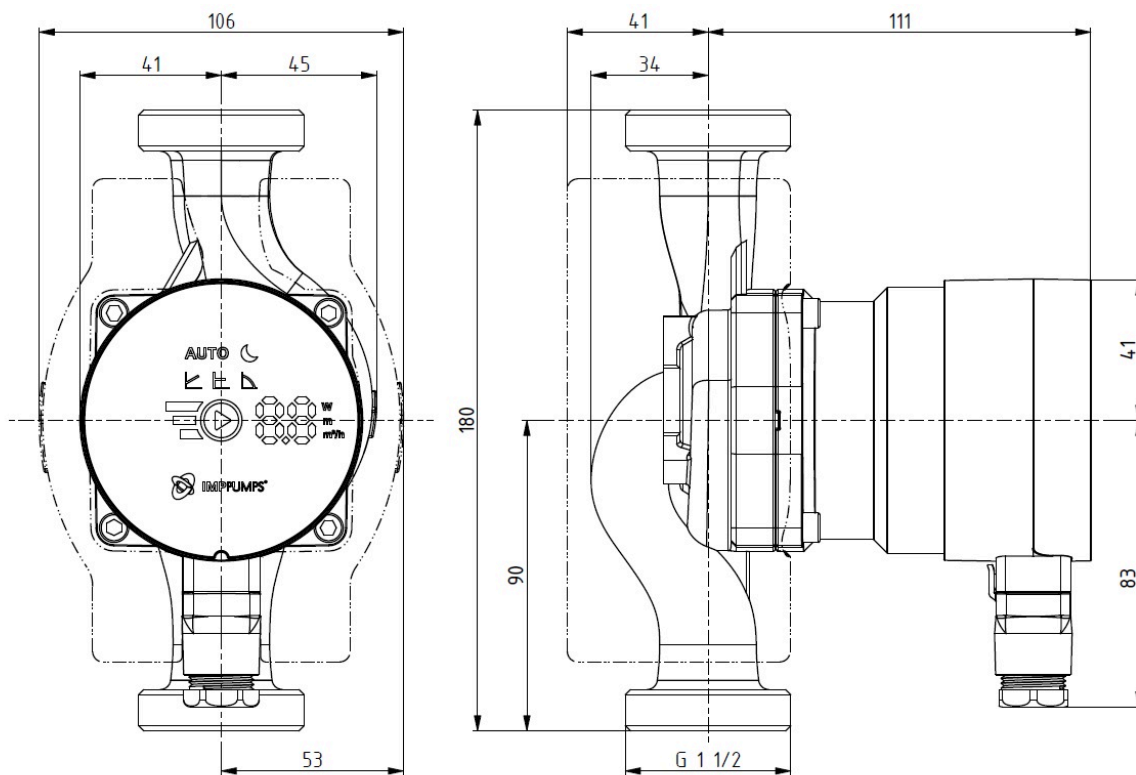



NMT MINI PRO 25/40-180

979525434

NMT MINI

Electrical wiring

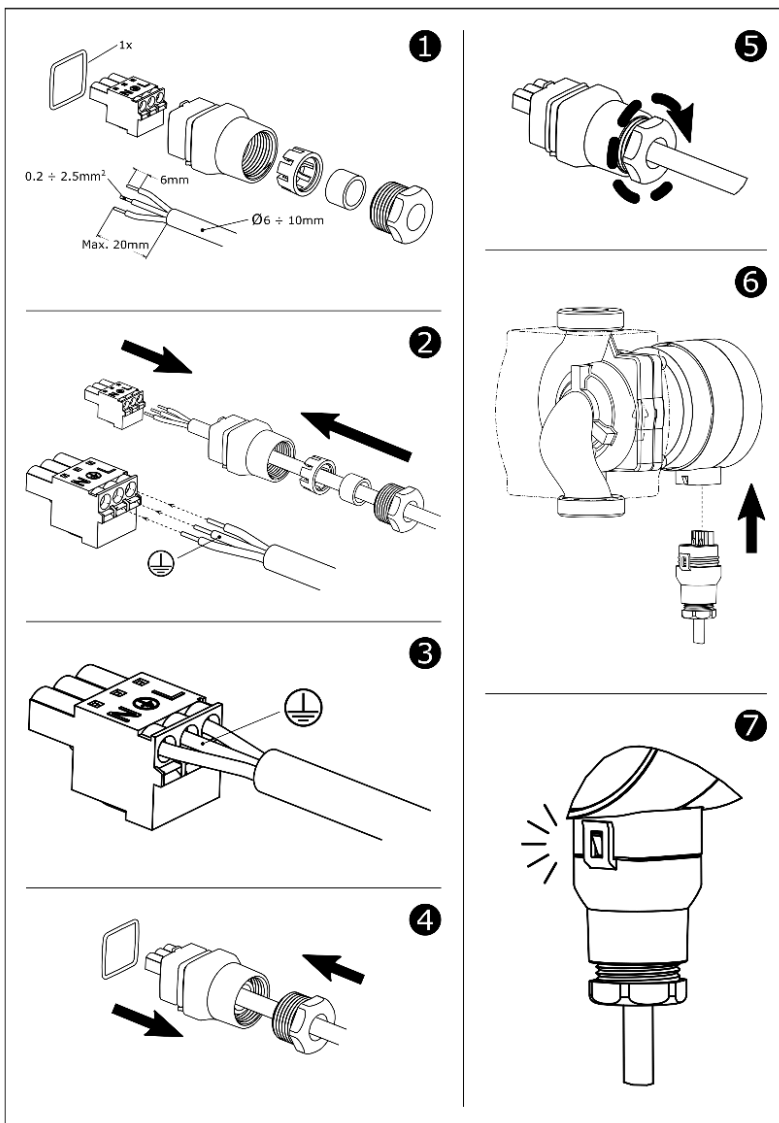



NMT MINI PRO 25/40-180

979525434

NMT MINI

NMT MINI PRO 25/40-180 is a high efficiency (Energy-Efficiency-Index (EEI) $\leq 0,18$) variable speed circulating pump meant for heating, air conditioning and cooling systems.

The pump includes a permanent magnet synchronous motor, the impeller speed is controlled by a built-in frequency converter.

The pump is controlled using a button on the screen, which displays the current power consumption (W), current pressure (m) and flow rate (m³/hour), as well as error messages. The error is indicated on the screen by a two-digit number that provides a more detailed description.

The following pump operating modes are available:

3 levels of regulation at proportional-pressure operating mode, recommended for radiator heating

3 levels of regulation at constant pressure operating mode, recommended for floor heating

3 levels of regulation at fixed speeds operating mode, recommended for heating and ventilation

summer mode - the pump is automatically switched on to minimum speed for a short time when the pump is in standby mode to prevent rotor blocking.

automatic mode - the pump control system finds the optimal operating point, this mode is used in most systems.

night mode (works in parallel with other settings) – when the temperature in the system drops, the pump reduces the speed to a minimum.

The pump has a built-in electronic protection unit that protects the pump from overload. The pump bearings are lubricated by the pumped medium. The pump is equipped with a dry-running protection system - the rotation of the impeller slows down to a minimum if there is no medium in the pump.

For normal operation of the pump, it is necessary to use a working medium consisting of clean water or a mixture of clean water and glycol in accordance with current water quality standards for heating systems, for example the German standard VDI 2035. If the glycol content in the working medium exceeds 20%, it is recommended to check the pump parameters Temperature range at an ambient temperature of +25 °C: +2...+110 °C, at ambient temperature +40 °C: +2...+95 °C.

Duty point:

- Flow: 0 m³/h
- Head: 0 m

Tolerances for head and flow according to ISO 9906-2015.

Electrical data:

- Voltage: 1~230 V
- Maximum current: 0.2 A

Installation data:

- DN: 25
- Installation length: 180 mm
- Net weight: 1.73 kg

The pump is available with threaded (PN10) connection. The hydraulic pump housing is made of gray cast iron, protected by a cathaphoresis coating, which makes the pump more resistant to the environment. The rotor can is made of one piece without welding, the rotor cladding is made of AISI 316 stainless steel, the pump shaft is made of AISI 316 stainless steel. The impeller is made of synthetic material reinforced with glass fiber PES GF30. The bearings are made of graphite.

Removable thermal insulation of the pump housing is included in the delivery package.