

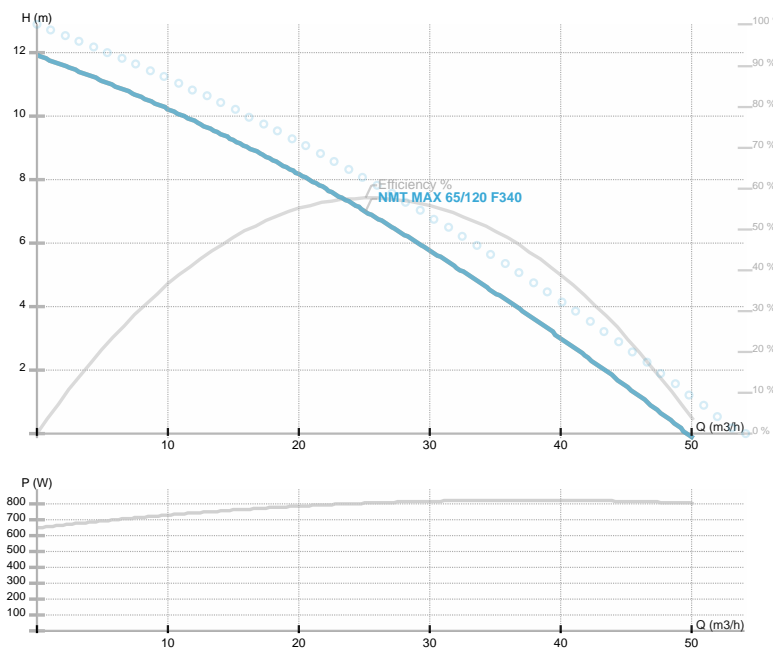

## NMT MAX 65/120 F340

NMT MAX F/ Electronically regulated circulating pump  
 Heating



Part number	<b>979524758</b>
Power supply	<b>1~230 V</b>
Declared protection	<b>IP44</b>
Q max	<b>50.2 [m³/h]</b>
H max	<b>11.91 [m]</b>
RPM	<b>3900 [1/min]</b>
Motor power	<b>810 [w]</b>
Declared current	<b>3.5 [A]</b>
Fluid	<b>Water VDI 2035, glycol 40%</b>
Fluid temperature	<b>-10.0 ÷ 110.0 [°C]</b>
Insulation class	<b>H</b>
DN	<b>65 [mm]</b>
Connector	<b>PN 6/10</b>
Net weight	<b>19.30 [kg]</b>
Length	<b>340 [mm]</b>
Approvals	<b>CE EAC</b>
EEL	<b>0.2</b>
Efficiency	<b>59.15 [%]</b>
Impeller material	<b>PES GF 30</b>
Bearing material	<b>Graphite</b>
Shaft material	<b>AISI 420</b>
Hydraulics material	<b>Gray cast iron</b>
Mains frequency	<b>50/60 Hz</b>
Connection	<b>PN 6/10</b>
Max pressure	<b>1.0 MPa</b>
Ambient temp.range	<b>40 deg C</b>

### Drawing

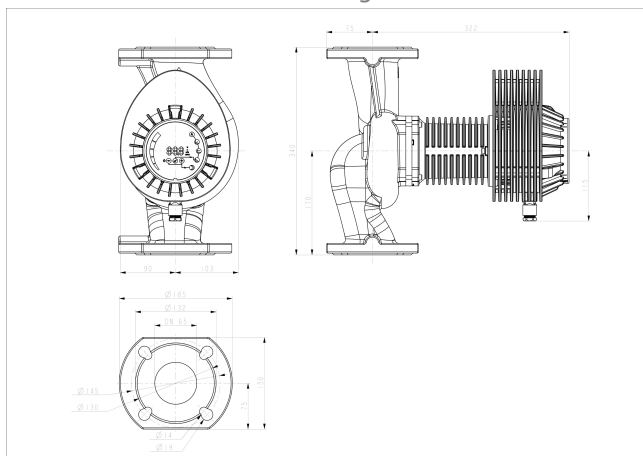

### Electrical wiring

