

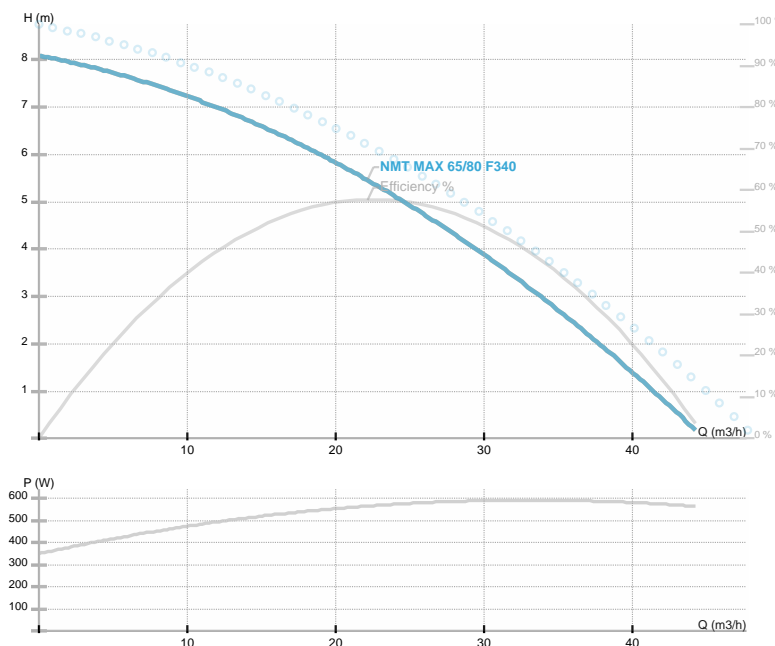

NMT MAX 65/80 F340

NMT MAX F/ Electronically regulated circulating pump
 Heating



Part number	979524757
Power supply	1~230 V
Declared protection	IP44
Q max	44.3 [m³/h]
H max	8.09 [m]
RPM	3200 [1/min]
Motor power	560 [w]
Declared current	2.6 [A]
Fluid	Water VDI 2035, glycol 40%
Fluid temperature	-10.0 ÷ 110.0 [°C]
Insulation class	H
DN	65 [mm]
Connector	PN 6/10
Net weight	16.35 [kg]
Length	340 [mm]
Approvals	CE EAC
EEL	0.22
Efficiency	58.2 [%]
Impeller material	PES GF 30
Bearing material	Graphite
Shaft material	AISI 420
Hydraulics material	Gray cast iron
Mains frequency	50/60 Hz
Connection	PN 6/10
Max pressure	1.0 MPa
Ambient temp.range	40 deg C

Drawing

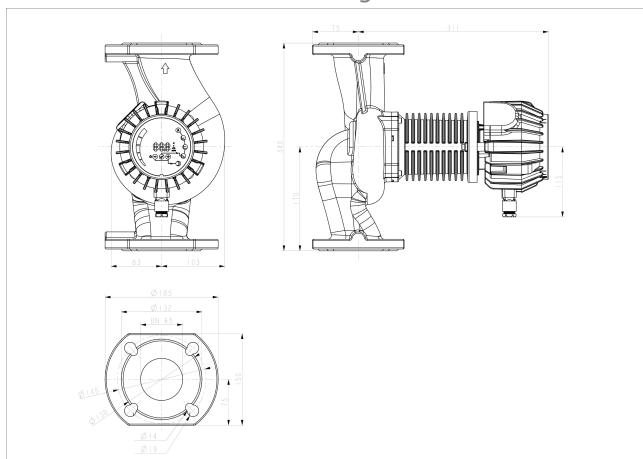

Electrical wiring

