



NMT MINI PRO 25/80-130

979525420

NMT MINI

GENERAL

Part number	979525420		
Part name	NMT MINI PRO 25/80-130	MEI	/
Seal type	/	EEl	0.18
Net weight	1.65 [kg]		
H max	8.2 [m]	H min	0.0 [m]
Q max	4.4 [m3/h]	Q min	0.0 [m3/h]
	[%]		
Noise	≤43 dB(A)		

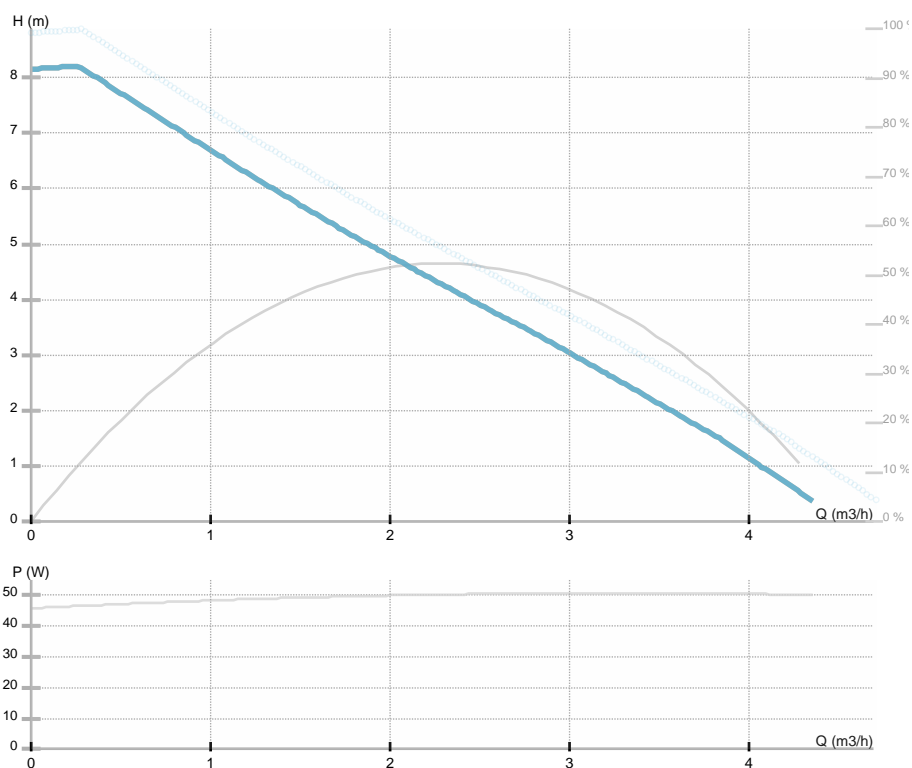

ELECTRICAL DATA

Power supply	1~230 V
Mains frequency	50/60 Hz
Motor power	50 [w]
RPM	5600 [1/min]
Insulation class	F
Declared current	0.45 [A]
Declared protection	IP44
Thermal protection	NTC
Frame size	
Motor IE class	/

INSTALLATION

Fluid	Water VDI 2035, glycol 40%
Fluid temperature	-10.0 ÷ 110.0 [°C]
Ambient temp.range	40 deg C
Length	130 [mm]
DN	25 [mm]
Connector	G 1 ½
Connection	G 1 ½
Max pressure	1.0 MPa

MATERIAL

Bearing material	all carbon
Impeller material	Noryl Fe 1630PW
Hydraulics material	Gray cast iron
Shaft material	AISI 420

NMT MINI PRO 25/80-130

979525420

NMT MINI





NMT MINI PRO 25/80-130

979525420

NMT MINI

Dimension drawing

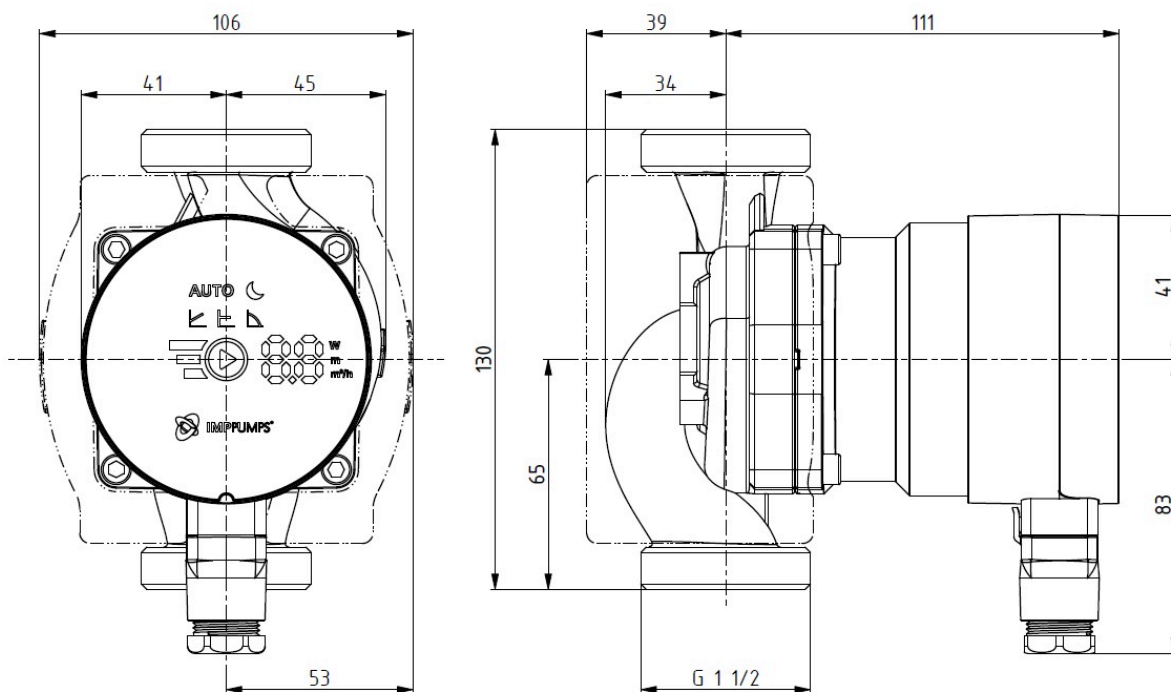



NMT MINI PRO 25/80-130

979525420

NMT MINI

Electrical wiring

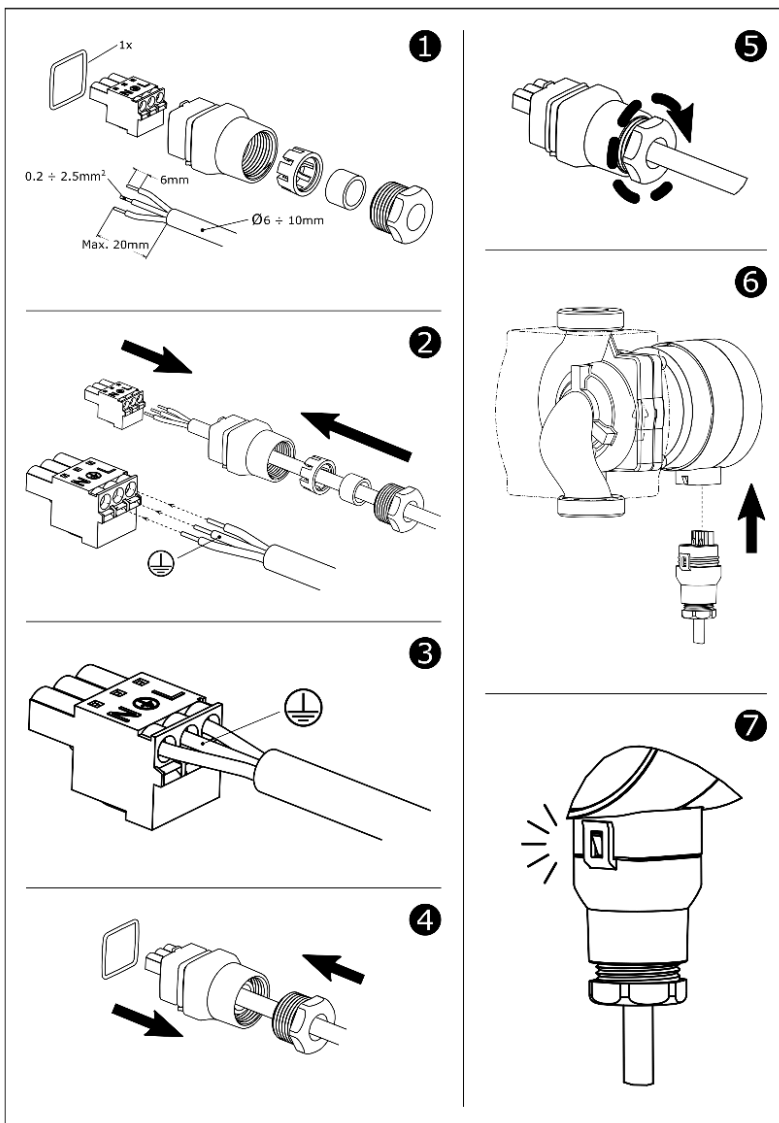



NMT MINI PRO 25/80-130

979525420

NMT MINI