



NMT SMART 32/40-180

979527120

NMT SMART / Electronically regulated circulating pump

GENERAL

Part number	979527120		
Part name	NMT SMART 32/40-180		
Seal type		EEl	0.19
Net weight	3.80 [kg]		
H max	4.2 [m]	H min	0.0 [m]
Q max	8.6 [m3/h]	Q min	0.0 [m3/h]
	[%]		
Noise	≤43 dB(A)		

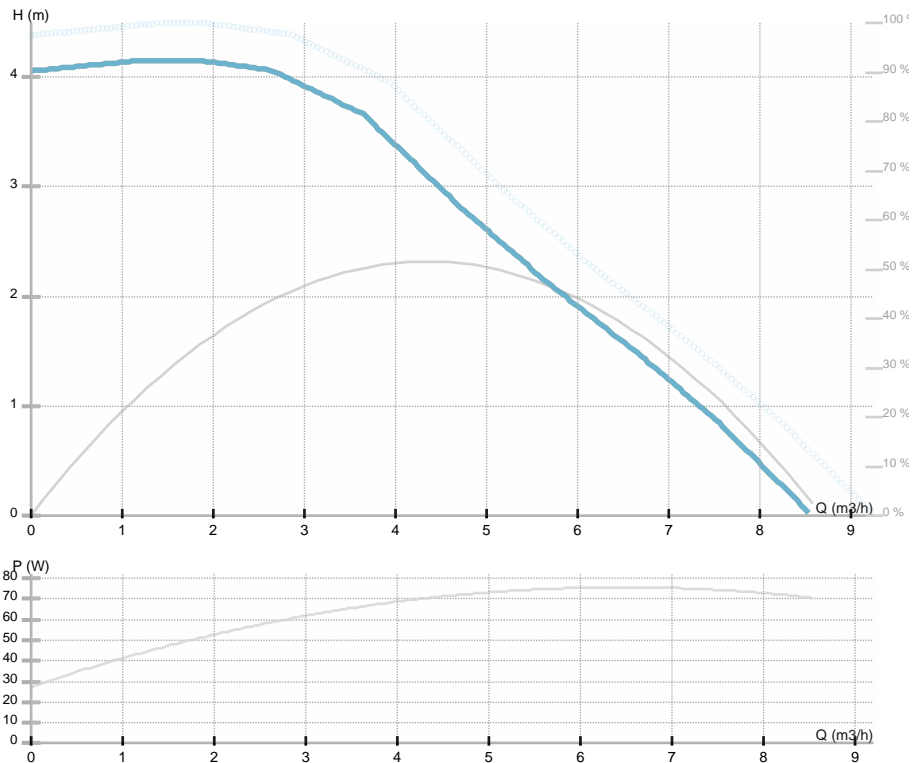

ELECTRICAL DATA

Power supply	1~230 V
Mains frequency	50/60 Hz
Motor power	70 [w]
RPM	2800 [1/min]
Insulation class	F
Declared current	0.6 [A]
Declared protection	IP44
Thermal protection	NTC
Frame size	
Motor IE class	

INSTALLATION

Fluid	Water VDI 2035, glycol 40%
Fluid temperature	-10.0 ÷ 110.0 [°C]
Ambient temp.range	40 deg C
Length	180 [mm]
DN	32 [mm]
Connector	G 2
Connection	G 2
Max pressure	1.0 MPa

MATERIAL

Bearing material	Graphite
Impeller material	PES GF 30
Hydraulics material	Gray cast iron
Shaft material	AISI 420

NMT SMART 32/40-180

979527120

NMT SMART / Electronically regulated circulating pump





NMT SMART 32/40-180

979527120

NMT SMART / Electronically regulated circulating pump

Dimension drawing

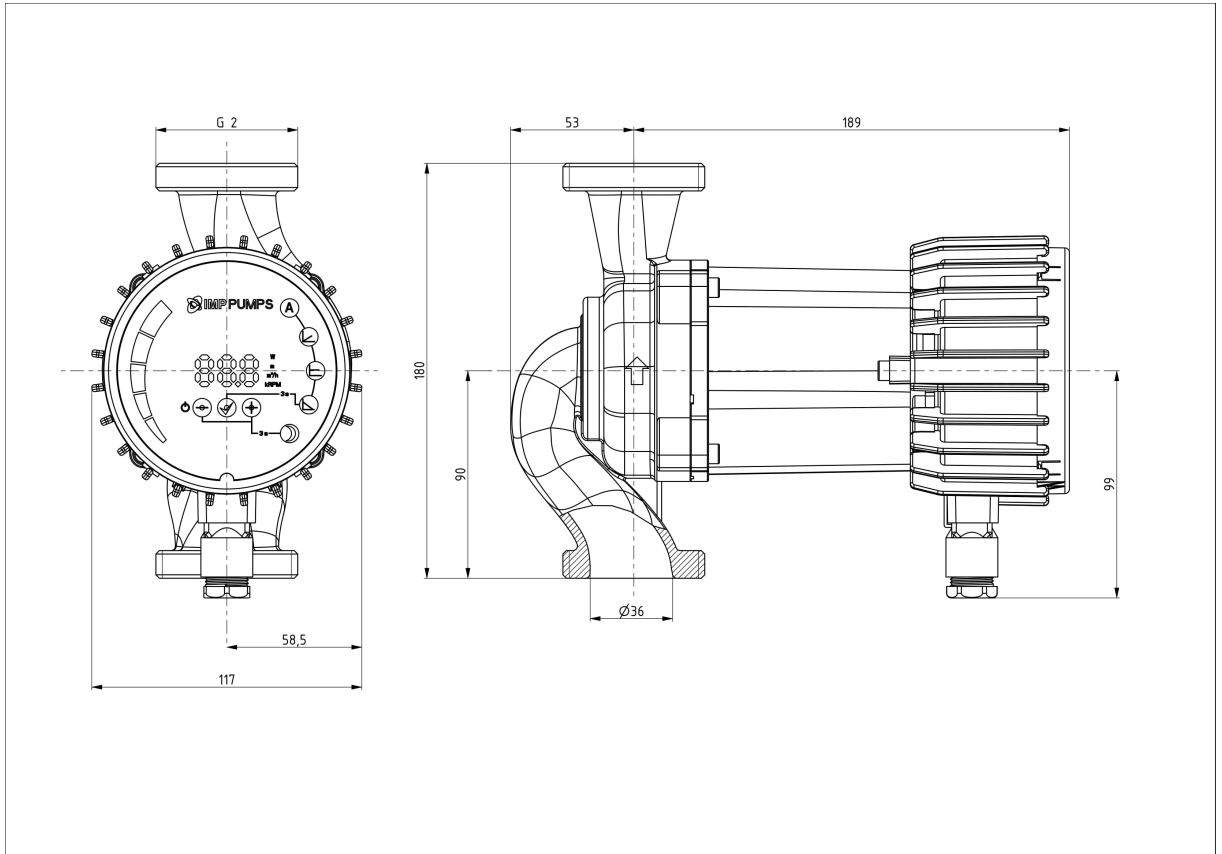

L=180 l=190 DN=32 D2=2



NMT SMART 32/40-180

979527120

NMT SMART / Electronically regulated circulating pump

Electrical wiring

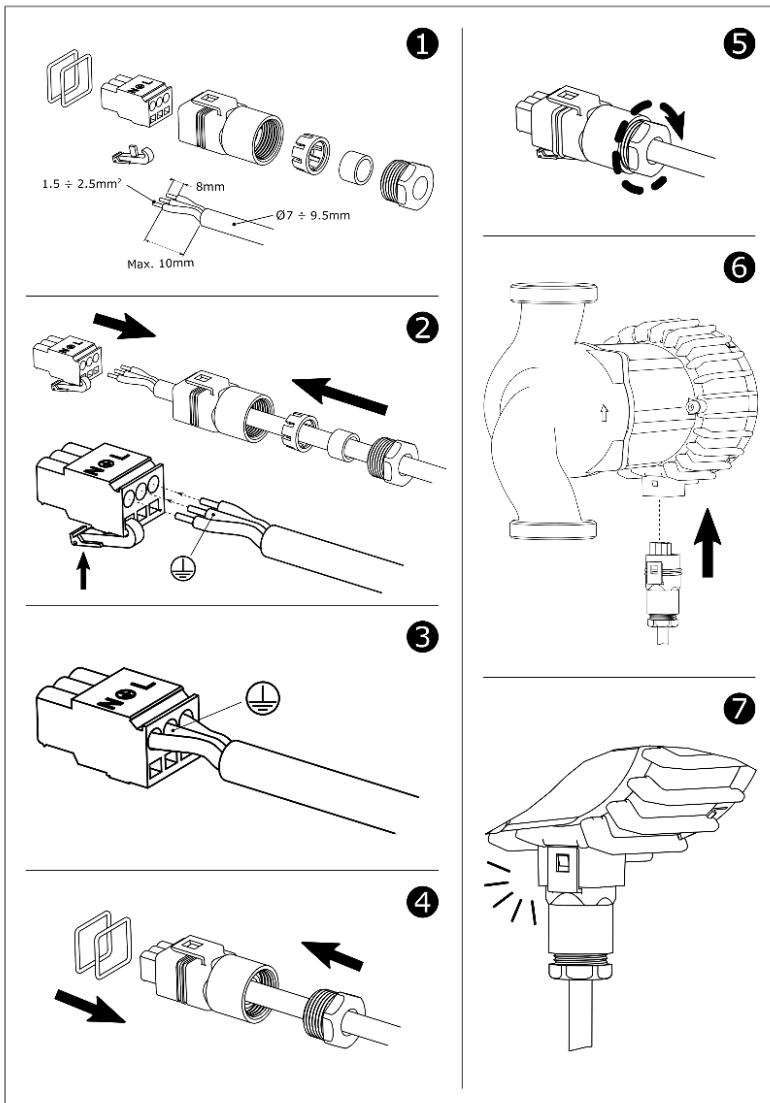



NMT SMART 32/40-180

979527120

NMT SMART / Electronically regulated circulating pump