



## NMT SMART C 25/40-180

979527141

NMT SMART C / Electronically regulated circulating pump - communication

### GENERAL

Part number	<b>979527141</b>		
Part name	<b>NMT SMART C 25/40-180</b>		
Seal type		EEl	<b>0.19</b>
Net weight	<b>3.50 [kg]</b>		
H max	<b>4.2 [m]</b>	H min	<b>0.0 [m]</b>
Q max	<b>8.6 [m3/h]</b>	Q min	<b>0.0 [m3/h]</b>
	<b>[%]</b>		
Noise	<b>≤43 dB(A)</b>		

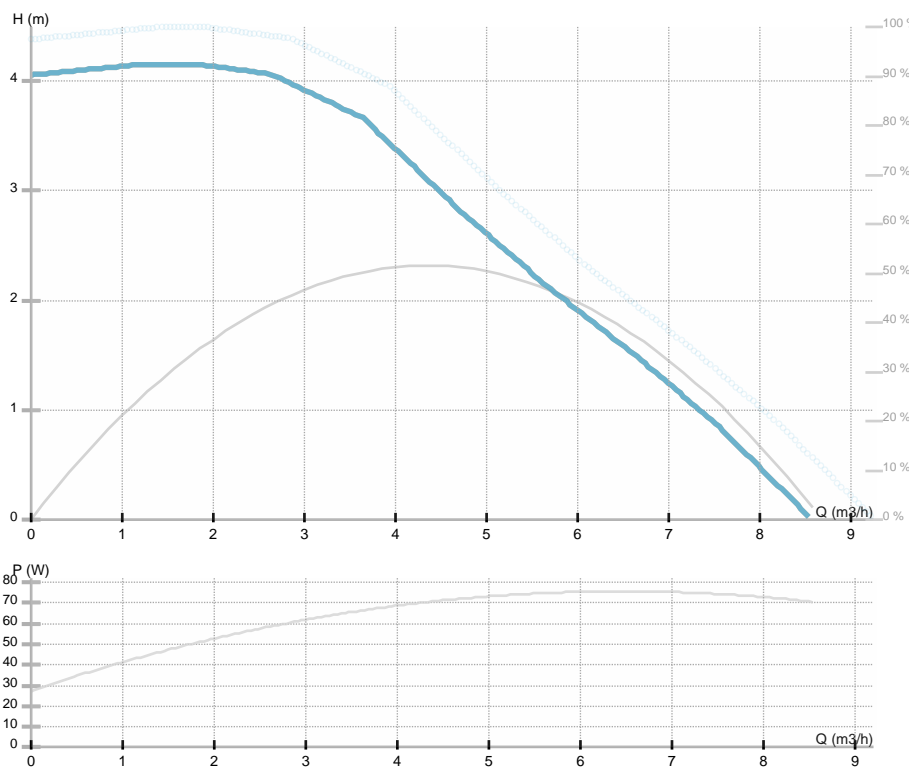

### ELECTRICAL DATA

Power supply	<b>1~230 V</b>
Mains frequency	<b>50/60 Hz</b>
Motor power	<b>70 [w]</b>
RPM	<b>2800 [1/min]</b>
Insulation class	<b>F</b>
Declared current	<b>0.6 [A]</b>
Declared protection	<b>IP44</b>
Thermal protection	<b>NTC</b>
Frame size	
Motor IE class	

### INSTALLATION

Fluid	<b>Water VDI 2035, glycol 40%</b>
Fluid temperature	<b>-10.0 ÷ 110.0 [°C]</b>
Ambient temp.range	<b>40 deg C</b>
Length	<b>180 [mm]</b>
DN	<b>25 [mm]</b>
Connector	<b>G 1 ½</b>
Connection	<b>G 1 ½</b>
Max pressure	<b>1.0 MPa</b>

### MATERIAL

Bearing material	<b>Graphite</b>
Impeller material	<b>PES GF 30</b>
Hydraulics material	<b>Gray cast iron</b>
Shaft material	<b>AISI 420</b>

## **NMT SMART C 25/40-180**

979527141

NMT SMART C / Electronically regulated circulating pump - communication





## NMT SMART C 25/40-180

979527141

NMT SMART C / Electronically regulated circulating pump -  
communication

Dimension drawing

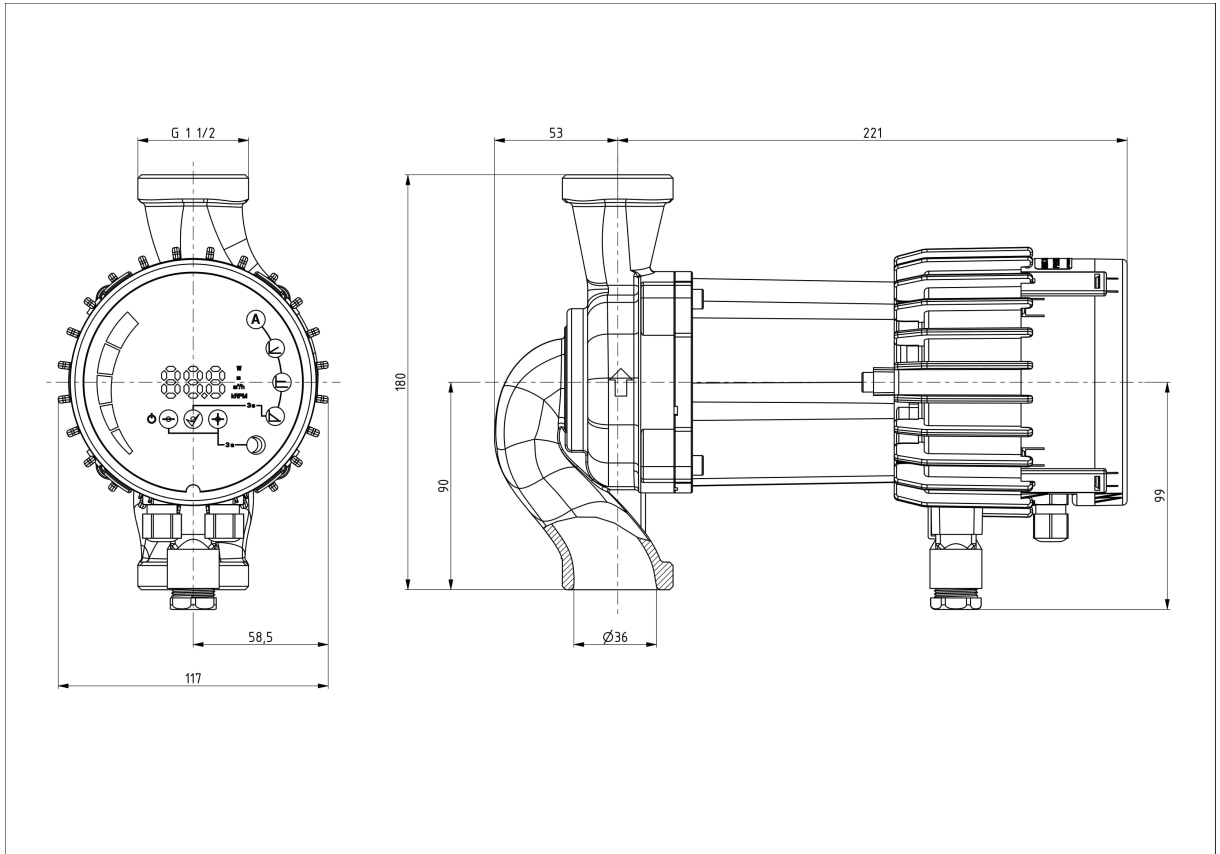



## NMT SMART C 25/40-180

979527141

NMT SMART C / Electronically regulated circulating pump - communication

### Electrical wiring

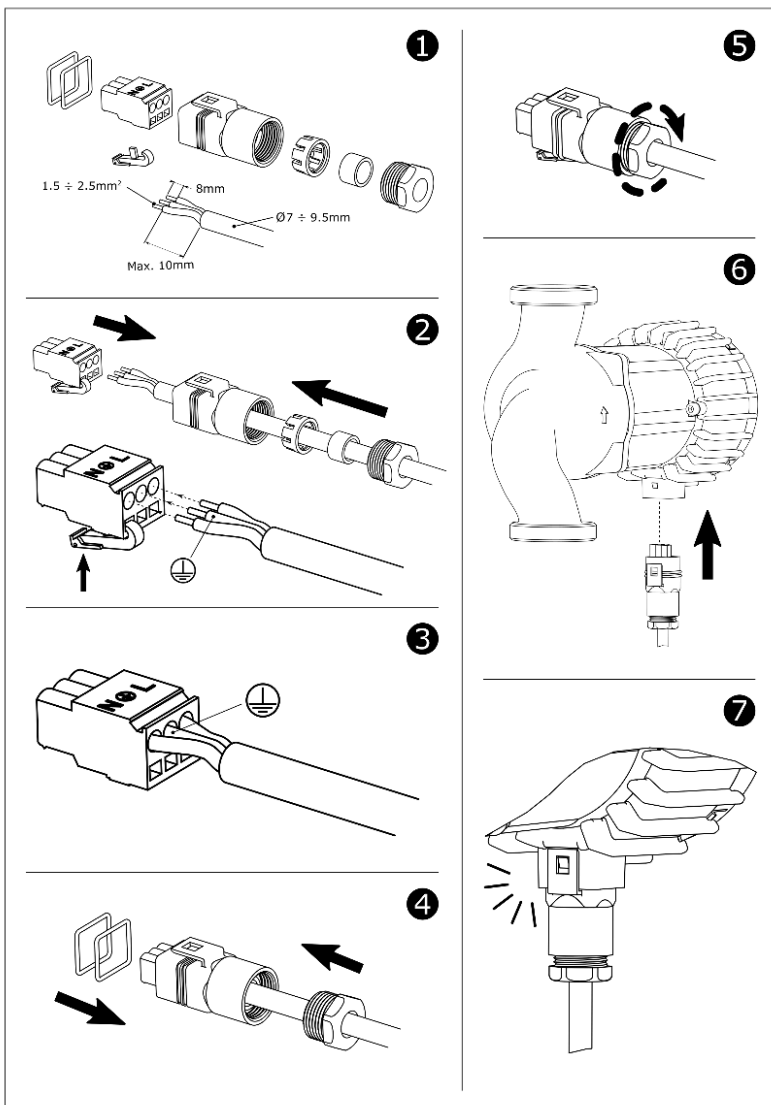



## **NMT SMART C 25/40-180**

979527141

NMT SMART C / Electronically regulated circulating pump -  
communication